



I Application

The INNOVA N-type valve is a pneumatic shut-off seat valve for hygienic applications.

I Design and features

- Hygienic design according to EHEDG.
- Gasket with specific profile guarantees reliability under adverse working conditions.
- Hygienic design of the gasket ensures optimal cleaning.
- Single-acting pneumatic actuator.
- Normally closed valve (NC).
- The valve can be changed to normally open (NO) by simply reversing the position of the pneumatic actuator.
- Easy assembly/disassembly of internal parts by loosening a clamp fastener.
- Open lantern allows visual inspection of shaft sealing.
- 360° adjustable body.
- The valve is authorized to carry 3-A symbol.
- Note: Consult the options of the valves authorized to carry 3-A symbol.



Standard Number 53-06

I Technical specifications

Materials:

Parts in contact with the product	AISI 316L (1.4404)
Other stainless steel parts	AISI 304 (1.4301)
Gasket	EPDM

Surface finish:

Internal	Bright polish Ra ≤ 0,8 µm
External	Matt

Available sizes:

DIN 11850	DN 25 - DN 100
ASME BPE	OD 1" - OD 4"

Connections

Weld

Operating limits:

Temperature range	-10 °C to+ 121 °C (EPDM)	14 °F to 250°F
	+140 °C (SIP, max. 30 min)	284 °F
Maximum working pressure	10 bar	145 PSI
Minimum working pressure	Vacuum	Vacuum
Compressed air pressure	6-8 bar	87-116 PSI

I Options

- Double-acting pneumatic actuator.
- Gaskets: FPM, HNBR.
- Other connection types.
- Control unit: C-TOP, C-TOP+ and C-TOP S.
- External position sensors.
- Surface finish: Ra ≤ 0,5 µm.



I Housing combinations

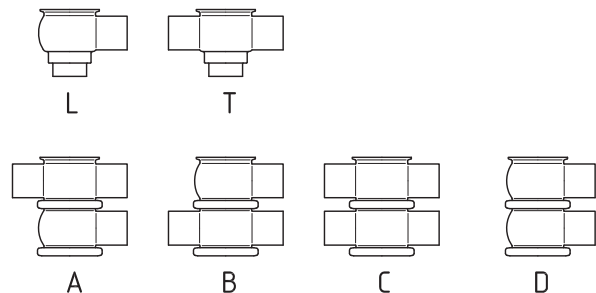

I Dimensions

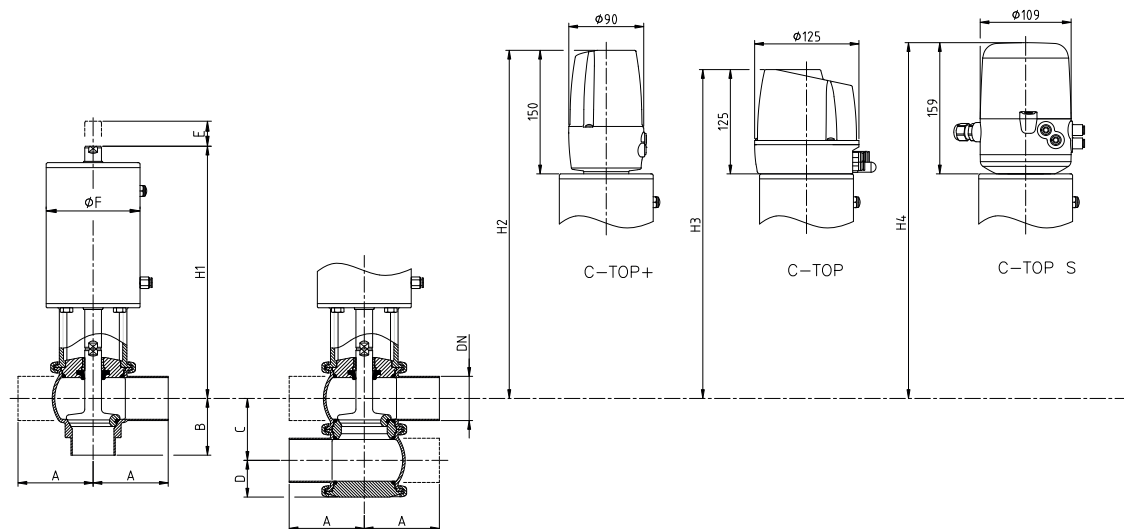

10.240.32.0052

	DN	Pipe Ø	A	B	C	D	ØF	E	H ₁	H ₂	H ₃	H ₄	kg
DN	25	29 x 1,5	50	50	50	32	87	17	239	367	342	376	4,6
	40	41 x 1,5	85	60	62	38	87	24	240	377	352	386	5,3
	50	53 x 1,5	90	68	74	44	112	31	302	433	408	442	9,1
	65	70 x 2,0	110	81	92	53	143	37	348	485	460	494	16
	80	85 x 2,0	125	90	107	60	143	37	355	492	467	501	17
	100	104 x 2,0	150	125	127	70	216	34	383	516	491	525	33
OD	1"	25,4 x 1,65	50	50	46	30	87	13	241	369	344	378	4,6
	1½"	38,1 x 1,65	85	60	59	36	87	20	242	379	354	388	5,3
	2"	50,8 x 1,65	90	68	72	43	112	28	304	434	409	443	9,1
	2½"	63,5 x 1,65	110	81	86	50	143	32	351	488	463	497	16
	3"	76,2 x 1,65	125	90	99	56	143	29	359	496	471	505	17
	4"	101,6 x 2,11	150	125	124	69	216	31	384	517	492	526	33

*The weights correspond to the "L" housing combination.

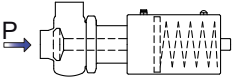
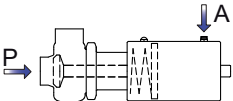
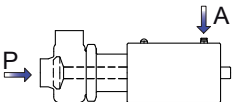

Maximum pressure in bar / PSI without leakage at the valve seat.

Actuator/valve body combination and direction of pressure	Air pressure	Plug position	OD 1"	OD 1½"	OD 2"	OD 2½"	OD 3"	OD 4"
	[bar] / [PSI]		DN 25	DN 40	DN 50	DN 65	DN 80	DN 100
	6 / 87	NC	10 / 145	5,7 / 82	5,1 / 74	5,1 / 74	4,4 / 64	4,7 / 68
	6 / 87	NO	10 / 145	8,2 / 119	5,6 / 81	5,9 / 85	5,2 / 76	10 / 145
	6 / 87	A/A	10 / 145	10 / 145	10 / 145	10 / 145	10 / 145	10 / 145

Maximum pressure in bar / PSI against which the valve can open.

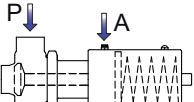
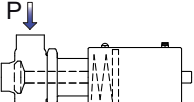
Actuator/valve body combination and direction of pressure	Presión aire	Posición obturador	OD 1"	OD 1½"	OD 2"	OD 2½"	OD 3"	OD 4"
	[bar] / [PSI]		DN 25	DN 40	DN 50	DN 65	DN 80	DN 100
	6 / 87	NC	10 / 145	10 / 145	10 / 145	8,6 / 125	7,7 / 111	10 / 145
	6 / 87	NO	10 / 145	7,1 / 102	10 / 145	8,3 / 121	7,1 / 102	5,4 / 78

A = Air
 P = Product pressure
 NC = Normally closed
 NO = Normally open
 A/A = Double acting

Note: Values for standard actuators.
 For other pressures, bigger actuators can be assembled.

