

PRODUCT CATALOG 2021

KEOFITT SINGLE-PORT



KEOFITT
WORLD LEADERS IN STERILE SAMPLING™



www.sks-online.com

KEOFITT SINGLE-PORT

Replace your ordinary, non-hygienic sampling cocks with the KEOFITT Single-Port Sampling Valve.

This valve is CIP-able with process CIP and still true to the Keofitt concept, as it is available with various process connections with manual or pneumatic operation.



HOW IT WORKS

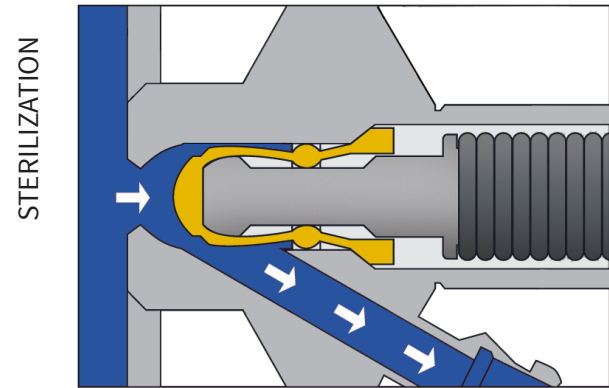
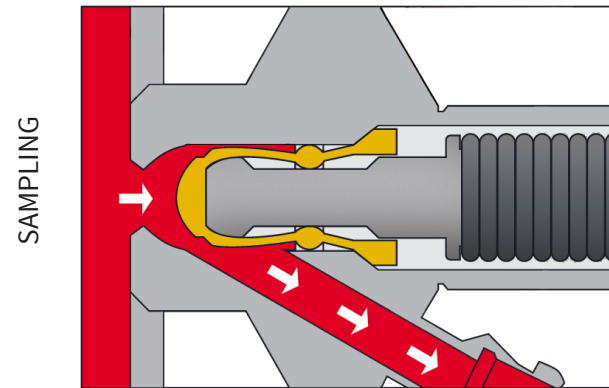

KEOFITT SINGLE-PORT W9™ SAMPLING VALVE

The KEOFITT Single-Port W9™ sampling valve is our solution for CIP-able sampling from less demanding applications. If the BASIX™ does not cover your need due its smaller size, the 9mm outlet on the Single-Port W9 will do the job. With the W9-solution you have the added benefit of choosing products from a selected range within the W9 product outline.

This valve is designed for sampling of products with a viscosity of 0-1000 cP with particles up to 3 mm in diameter.

The Single-Port W9 valve is usable for simple, hygienic sampling in all industries for products such as:

Water

Milk

Perfume

Fruit juice

Available in many versions; choose your preferred type of head from our W9 product outline.



KEOFITT SINGLE-PORT W9 - BODIES

SINGLE-PORT W9 BODIES

HOSE PIECE

WELDING BODIES

TANK WELDING



850001-1

PIPE WELDING 1"



850011-1

CONNECTION BODIES

VARIVENT Ø50



850008-1

VARIVENT Ø68



850009-1

MINI CLAMP



850036-1

CLAMP 1" & 1½"



850021-1

* CHOOSE VALVE HEAD AND PARTS & ACCESSORIES FROM THE W9 SECTION

* CHOOSE VALVE HEAD AND PARTS & ACCESSORIES FROM THE W9 SECTION

HOW IT WORKS

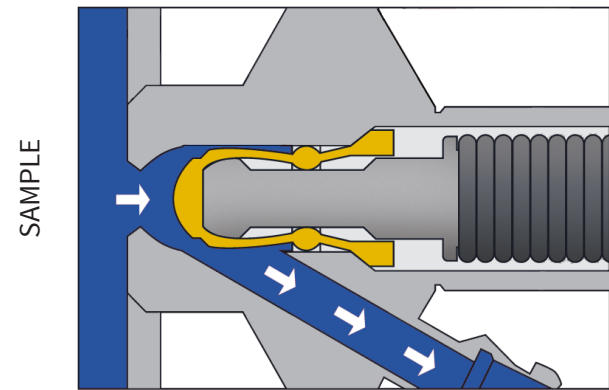
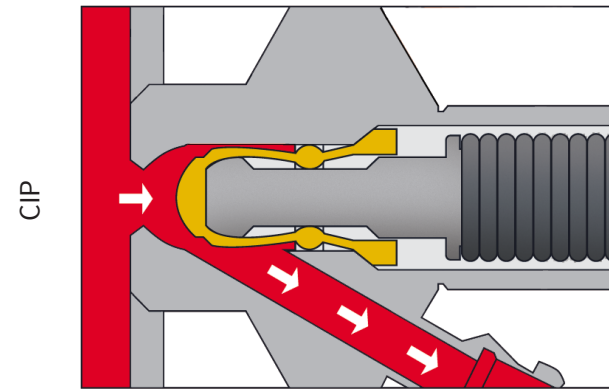

KEOFITT BASIX SAMPLING VALVE

The KEOFITT BASIX™ Sampling Valve is our basic CIP-able sampling valve for less demanding applications. The KEOFITT BASIX™ Sampling Valve is our product category for process CIP-able sampling valves for less demanding applications that require no separate inlet for sterilizing or sanitizing media.

This valve is designed for sampling of low viscosity products in the range of 0-100 cP with particles less than 1,5 mm in diameter.

Basix™ is used for simple, hygienic sampling in all industries for products such as:

Water

Milk

Perfume





Fruit Juice





Available in manual and pneumatic versions this valve is offered complete as a valve body and valve head combination.

Choose from silicone, EPDM or PTFE membranes.



KEOFITT BASIX SAMPLING VALVES

		MANUAL VALVE			
		TANK WELDING	PIPE WELDING	MINI CLAMP	1" & 1½" CLAMP
HOSE PIECE					
	SILICONE	450141	451141	452141	452241
	EPDM	450141EPDM	451141EPDM	452141EPDM	452241EPDM
	PTFE	450141PTFE	451141PTFE	452141PTFE	452241PTFE

		PNEUMATIC VALVE			
		TANK WELDING	PIPE WELDING	MINI CLAMP	1" & 1½" CLAMP
HOSE PIECE					
	SILICONE	450144	451144	452144	452244
	EPDM	450144EPDM	451144EPDM	452144EPDM	452244EPDM
	PTFE	450144PTFE	451144PTFE	452144PTFE	452244PTFE

KEOFITT BASIX™

HOSE PIECE















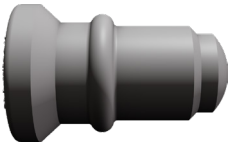

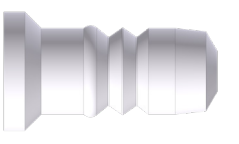

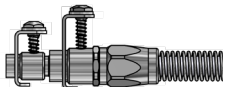



SILICONE









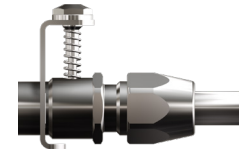

EPDM

PTFE

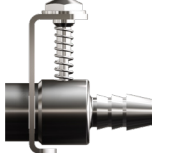
KEOFITT BASIX - PARTS & ACCESSORIES

BASIX™ PARTS & ACCESSORIES

O-RING	 600825 SILICONE 7.1X1.6	 550184 FESTO	 800830 SILICONE 10.3X2.4	 830830E EPDM 10.3X2.4
	MEMBRANE	 400051 SILICONE	 400052 EPDM	 400055 PTFE
FOR HOSE PIECE	 550002 PTFE QC 0.5M	 550003 PTFE QC 1.0M	 550002.2 PTFE QC/TC 0.5M	 550003.2 PTFE QC/TC 1M
	 800083 QC TC	 900045 QC SYRINGE INJECTION	 600062 RUBBER CAP	 450063 SINGLE ST.ST. CHAIN
	 600170 LEVER HANDLE Q/N	 600370 LEVER HANDLE SELF-CLOSING	 800052 HOSE PIECE/HOSE PIECE W9	 400255 TOOL FOR MEMBRANE (PTFE)
	 900091 GASKET EPDM 1"	 900018 TOMMY BAR	 900031 HP W9/MALE THREAD M12	 900047 TUBE PTFE 10/8MM

 800086 QC W9 WITH M4 HP	 800061 QC PLUG	 800070 QC STEEL PIPE	 800091 QC PTFE	 800082 QC W9 HOSE ID 7
 800058 SAMPLING COIL W9	 800059 SAMPLING COIL XL W9			
 900075 CLAMP RING 1/2"	 900086 CLAMP RING 1"			
 900087 GASKET MINI CLAMP 1/2" EPDM	 440149 BUSHING FOR 4KAI/ BASIX HEAD			