



EN DIN (ISO/Metric)

De belangrijkste normreeks binnen Europa voor industriële (niet hygiënische) toepassing bestaat uit 2 maatreeksen. De ISO 1127 maatreeks en de metrische maten die zijn omschreven in de norm SSG1361. Uitgangspunt voor beide reeksen is de EN 10217-7 en de EN 10296-2. In de norm EN 10217-7 worden de buizen gespecificeerd die bedoeld zijn voor transportleiding waar druk > 0,5 bar is of corrosiebestendigheid een eis is. Buizen die zijn bedoeld voor constructieve, decoratieve doeleinden of als transport leiding zonder technische eisen, worden gespecificeerd in de EN 10296-2. Het verschil zit vooral in de kwaliteit van de lasnaad en de manier waarop de buis getest is. Daarnaast zijn veel maten ook leverbaar in een naadloze uitvoering volgens EN 10216-5. Alle drie de normen zijn bij S.K.S. verkrijgbaar, maar als standaard houden wij de norm EN 10217-7 aan. Omdat de maten uit de Amerikaanse norm ASTM A-312 ongeveer overeen komen met de maten volgens ISO 1127, worden deze componenten vaak door elkaar gebruikt.

Industrial



Reeks	EN DIN	ISO	Metric
Buis	EN 10217-7 EN 10296-2 EN 10216-5	ISO 1127	SSG 1361
Lasfittings	EN 10253-3 EN 10253-4 EN 10241 (BSP)	ISO 5251	SSG 1362 bocht SSG 1363 T-stuk SSG 1364 Verloop SSG 1369 Eindcap
Verbindingen	EN 1092-1 BSP koppeling	EN 1092-1 BSP koppeling	SSG 1366 Boordrand EN 1092-1 BSP koppeling Knelkoppelingen
Toepasbare koppeling	Divers	DIN 11851 ISO DIN 11864 RB Divers	Divers

Buis EN 10217-7

Deze norm is de meest actuele en toonaangevende productiemethode voor alle buizen t.b.v. transportleiding. Alle serieuze producenten hanteren deze norm voor alle maatreeksen industriële buis die verkrijgbaar is. Gezien de toleranties en de diverse afwerking mogelijkheden, is er echter wel een enorm breed aanbod. Hierin zijn de verschillende kwaliteiten ook voorzien van een ander prijsniveau. Daarnaast zijn er ook buizen in omloop die aan de maat voldoen maar absoluut niet aan de overige gestelde eisen. Let op deze valkuil. Controleer het gekregen materiaal ook op markering en bijbehorend certificaat. De EN 10217-7 heeft een directe link met de PED. (Pressure Equipment Directive 97/23/EC) S.K.S. werkt alleen samen met producenten die gecertificeerd zijn volgens de PED eis.

Materiaal volgens EN 10088-1

Roestvaststaal soorten; 1.4301 (304), 1.4306 of 1.4307 (304L) en 1.4401 (316), 1.4404 of 1.4432 (316L). Daarnaast is er een redelijke verkrijgbaarheid in 1.4571 (316Ti) of 1.4541 (321)

Maattabel en toleranties volgens EN-ISO 1127

Maatreeksen

ISO 1127 serie 1, 2 en 3

Metrische maten volgens SSG 1361

Diameter tolerantie D3 of D4 t/m 168.3 mm, D2 vanaf 168.3 mm

Wanddikte tolerantie T3 voor alle maten wanddikte.

Daarnaast is er een duidelijke tolerantie op de hoogte van de lasnaad in verhouding met de wanddikte.

Test procedure EN 10217-7 TC1 of TC2:

Destructieve en non-destructieve testen volgens tabel 13 (EN 10246)

Uitvoering

Productie proces (route) is volgens tabel 1, het resultaat wordt aangeduid met een symbool. De meest voorkomende zijn:

W1 of W2: Gelaste buis ongegloeid uit koud of warm gewalste strip.

W1A of W2A: Gelaste buis gegloeid uit koud of warm gewalste strip

W1R of W2R: Gelaste buis blankgegloeid uit koud of warm gewalste strip

1 uitvoering is uit plaat finish 1D

2 uitvoering is uit plaat finish 2D, 2E of 2B

Indien de code aangevuld is met een "b", is de lasnaad weggerold (nabewerkt)

Certificaten

3.1 certificaat Volgens EN 10204 (3.2 certificaat ook mogelijk op aanvraag)

Maat Inch / NW	ISO 1127			SSG 1361 Metric			Seamless (Hydraulic)			
	serie 1	serie 2	serie 3	serie 1	serie 2	serie 3	serie 1	serie 2	serie 3	serie 4
	-	-	-	-	-	-	4 x 0,5			
	-	-	-	6 x 1	-	-	6 x 0,5	6 x 1	6 x 1,5	
	-	-	-	8 x 1	-	-		8 x 1	8 x 1,5	
	-	-	-	10 x 1	-	-		10 x 1	10 x 1,5	
0,25" / 8	-	-	13,5 x 2,3	12 x 1	12 x 1,5	-		12 x 1	12 x 1,5	
0,375" / 10	17,2 x 1,6	17,2 x 2	17,2 x 2,6	18 x 1	18 x 1,5	-		13 x 1	13 x 1,5	
0,5" / 15	21,3 x 1,6	21,3 x 2	21,3 x 2,6	20 x 1	20 x 1,5	-		14 x 1	14 x 1,5	
0,75" / 20	26,9 x 1,6	26,9 x 2	26,9 x 2,6	25 x 1	25 x 1,5	25 x 2		15 x 1	15 x 1,5	15 x 2
1" / 25	33,7 x 1,6	33,7 x 2	33,7 x 2,6	28 x 1	28 x 1,5	30 x 2		16 x 1	16 x 1,5	
1,25" / 32	42,4 x 1,6	42,4 x 2	42,4 x 2,6	40 x 1	40 x 1,5	40 x 2			18 x 1,5	18 x 2
1,5" / 40	48,3 x 1,6	48,3 x 2	48,3 x 2,6	-	-	44,5 x 2			20 x 1,5	
2" / 50	60,3 x 1,6	60,3 x 2	60,3 x 2,6	52 x 1	52 x 1,5	54 x 2			22 x 1,5	22 x 2
2,5" / 65	76,1 x 1,6	76,1 x 2	76,1 x 2,9	-	-	70 x 2			25 x 1,5	25 x 2
3" / 80	88,9 x 1,6	88,9 x 2	88,9 x 2,9	-	83 x 1,5	84 x 2			28 x 1,5	28 x 2
3,5"	-	101,6 x 2	-	-	103 x 1,5	104 x 2			30 x 1,5	30 x 2
4" / 100	114,3 x 1,6	114,3 x 2	114,3 x 2,6	-	-	108 x 2			38 x 1,5	38 x 2
5" / 125	139,7 x 2	139,7 x 2,6	139,7 x 3	-	-	129 x 2				50 x 2
6" / 150	168,3 x 2	168,3 x 2,6	168,3 x 3	-	153 x 1,5	154 x 2				
8" / 200	219,1 x 2	219,1 x 2,6	219,1 x 2,9	-	-	204 x 2				
10" / 250	273 x 2	273 x 2,6	273 x 3	-	254 x 2	256 x 3				
12" / 300	-	323,9 x 2,6	323,9 x 3	-	-	306 x 3				
14" / 350	-	355 x 2,6	356 x 3	-	-	356 x 3				
16" / 400	-	-	406 x 3	-	-	406 x 3				

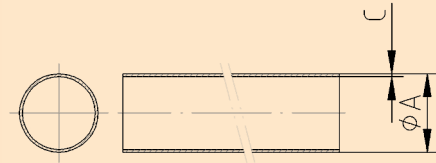

GELASTE BUIS ISO ISO EN 10217-7 ISO

DN	ISO	A	B	C	D	E	Kg	304(L)	316L
8	0,125"	10,20		2,00			0,319	40414041	40418041
8	0,25"	13,50		2,00			0,580	40414069	40418069
8	0,25"	13,50		2,30			0,650	40414070	40418070
10	0,375"	17,20		1,60			0,625	40414109	40418109
10	0,375"	17,20		2,30			0,858	40414112	40418112
10	0,375"	17,20		3,20			1,120	40414115	40418115
15	0,5"	21,30		1,60			0,789	40414158	40418158
15	0,5"	21,30		2,00			0,967	40414159	40418159
15	0,5"	21,30		2,60			1,217	40414161	40418161
15	0,5"	21,30		3,20			1,450	40414163	40418163
20	0,75"	26,90		1,60			1,014	40414222	40418222
20	0,75"	26,90		2,00			1,247	40414223	40418223
20	0,75"	26,90		2,60			1,582	40414225	40418225
25	1"	33,70		1,60			1,286	40414295	40418295
25	1"	33,70		2,00			1,588	40414296	40418296
25	1"	33,70		2,60			2,025	40414299	40418299
25	1"	33,70		3,20			2,444	40414302	40418302
32	1,25"	42,40		1,60			1,635	40414382	40418382
32	1,25"	42,40		2,00			2,023	40414383	40418383
32	1,25"	42,40		2,60			2,591	40414385	40418385
32	1,25"	42,40		3,20			3,141	40414388	40418388
40	1,5"	48,30		1,60			1,871	40414427	40418427
40	1,5"	48,30		2,00			2,319	40414428	40418428
40	1,5"	48,30		2,60			2,975	40414431	40418431
40	1,5"	48,30		3,20			3,614	40414434	40418434
50	2"	60,30		2,00			2,920	40414519	40418519
50	2"	60,30		2,60			3,757	40414521	40418521
50	2"	60,30		3,60			5,111	40414525	40418525
65	2,5"	76,10		1,60			2,985	40414592	40418592
65	2,5"	76,10		2,00			3,711	40414594	40418594
65	2,5"	76,10		2,60			4,785	40414597	40418597
65	2,5"	76,10		2,90			5,310	40414598	40418598
80	3"	88,90		2,00			4,352	40414640	40418640
80	3"	88,90		2,60			5,618	40414643	40418643
80	3"	88,90		3,20			6,867	40414646	40418646
80	3"	88,90		4,05			8,504	40414649	40418649

vervolg tabel op pag. 7

vervolg tabel van pag. 6

DN	ISO	A	B	C	D	E	Kg	304(L)	316L
100	3,5"	101,60		3,00			7,407	40414678	40418678
100	4"	114,30		2,00			5,624	40414722	40418722
100	4"	114,30		2,60			7,272	40414724	40418724
100	4"	114,30		3,60			9,979	40414728	40418728
100	4"	114,30		4,00			11,048	40414729	40418729
100	4"	114,30		4,50			12,400	40414731	40418731
125	5"	139,70		2,00			6,896	40414774	40418774
125	5"	139,70		2,60			8,926	40414777	40418777
125	5"	139,70		3,00			10,269	40414779	40418779
150	6"	168,30		2,00			8,328	40414807	40418807
150	6"	168,30		2,60			10,788	40414810	40418810
150	6"	168,30		3,00			12,417	40414812	40418812
200	8"	219,10		2,00			10,872	40414848	40418848
200	8"	219,10		2,60			14,095	40414851	40418851
200	8"	219,10		3,00			16,233	40414853	40418853
250	10"	273,00		2,00			13,572	40414876	40418876
250	10"	273,00		3,00			20,282	40414881	40418881
300	12"	323,90		3,00			24,106	40414918	40418918

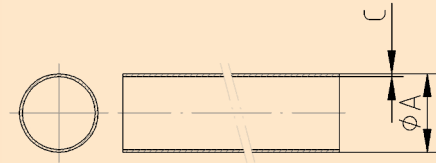

GELASTE BUIS METRISCH METRIC EN 10217-7 METRISCH

DN	ISO	A	B	C	D	E	Kg	304(L)	316L
4		6,00		1,00			0,125	40414015	40418015
6		8,00		1,00			0,175	40414021	40418021
8		10,00		1,00			0,225	40414031	40418031
8		10,00		1,50			0,319	40414033	40418033
8		12,00		1,00			0,275	40414052	40418052
8		12,00		1,50			0,394	40414055	40418055
8		13,00		1,50			0,432	40414063	40418063
10		14,00		1,00			0,326	40414078	40418078
10		14,00		1,50			0,470	40414080	40418080
10		15,00		1,50			0,507	40414087	40418087
10		15,00		2,00			0,537	40414088	40418088
10		16,00		1,00			0,376	40414093	40418093
10		16,00		1,50			0,545	40414095	40418095
10		17,00		1,00			0,401	40414102	40418102
10		17,00		1,50			0,582	40414103	40418103
15		18,00		1,00			0,426	40414123	40418123
15		18,00		1,50			0,620	40414125	40418125
15		18,00		2,00			0,801	40414126	40418126
15		19,00		1,50			0,657	40414135	40418135
15		20,00		1,00			0,476	40414138	40418138
15		20,00		1,50			0,695	40414140	40418140
15		20,00		2,00			0,901	40414142	40418142
20		22,00		1,00			0,526	40414166	40418166
20		22,00		1,50			0,770	40414168	40418168
20		23,00		1,50			0,808	40414180	40418180
20		25,00		1,50			0,883	40414199	40418199
20		25,00		2,00			1,152	40414201	40418201
20		25,40		2,00			1,172	40414216	40418216
25		28,00		1,00			0,676	40414238	40418238
25		28,00		1,50			0,995	40414240	40418240
25		28,00		2,00			1,302	40414241	40418241
25		30,00		1,50			1,070	40414258	40418258
25		30,00		2,00			1,402	40414259	40418259
25		32,00		2,00			1,502	40414279	40418279
32		35,00		1,50			1,258	40414320	40418320
32		35,00		2,00			1,653	40414321	40418321

vervolg tabel op pag. 9

vervolg tabel van pag. 8

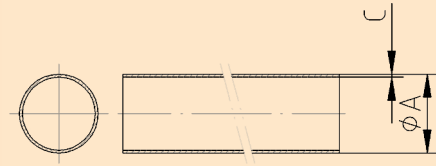
DN	ISO	A	B	C	D	E	Kg	304(L)	316L
32		38,00		2,00			1,803	40414338	40418338
32		38,10		2,00			1,813	40414356	40418356
32		40,00		1,50			1,446	40414362	40418362
32		40,00		2,00			1,903	40414363	40418363
40		44,50		1,50			1,615	40414402	40418402
40		44,50		2,00			2,128	40414404	40418404
40		45,00		1,50			1,634	40414415	40418415
50		50,00		2,00			2,404	40414444	40418444
50		50,80		2,00			2,444	40414455	40418455
50		51,00		2,00			2,454	40414461	40418461
50		52,00		1,50			1,897	40414469	40418469
50		53,00		1,50			1,934	40414473	40418473
50		54,00		2,00			2,604	40414482	40418482
50		57,00		1,50			2,085	40414494	40418494
50		57,00		2,00			2,754	40414495	40418495
65		63,50		2,00			3,080	40414544	40418544
65		64,00		2,00			3,105	40414550	40418550
65		70,00		2,00			3,405	40414566	40418566
65		76,10		3,60			6,535	40414601	40418601
80		83,00		1,50			3,061	40414627	40418627
80		84,00		2,00			4,107	40414630	40418630
80		85,00		2,50			5,165	40414633	40418633
100		104,00		2,00			5,108	40414694	40418694
100		106,00		3,00			7,737	40413699	40418699
100		108,00		2,00			5,308	40413704	40418704
100		108,00		3,00			7,888	40413706	40418706
100		108,00		4,00			10,417	40414709	40418709
125		129,00		2,00			6,360	40413754	40418754
125		133,00		2,00			6,550	40413760	40418760
150		154,00		2,00			7,612	40413790	40418790
150		156,00		3,00			11,493	40413794	40418794
150		158,00		4,00			15,400	40414796	40418796
150		159,00		2,00			7,863	40413798	40418798
200		204,00		2,00			10,116	40413834	40418834
200		206,00		3,00			15,249	40413838	40418838
250		254,00		2,00			12,620	40413867	40418867
250		256,00		3,00			19,005	40413871	40418871
300		304,00		2,00			15,124	40413901	40418901
300		306,00		3,00			22,761	40413905	40418905
400		406,00		3,00			30,303	40413944	40418944
450		456,00		3,00			34,000	40414956	40418956
500		506,00		3,00			37,900	40413966	40418966
600		606,00		3,00			44,500	40413973	40418973



NAADLOZE BUIS EN 10216-5 METRISCH

DN	A	B	C	D	E	Kg	304(L)	316L
4	4,00		0,5			0,061	43413007	43418007
4	5,00		0,5			0,065	43413010	43418010
4	6,00		0,5			0,069	43413014	43418014
4	6,00		1,0			0,125	43413015	43418015
6	8,00		1,0			0,175	43413021	43418021
6	8,00		1,5			0,262	43413022	43418022
8	10,00		1,0			0,225	43413031	43418031
8	10,00		1,5			0,319	43413033	43418033
8	12,00		1,0			0,275	43413052	43418052
8	12,00		1,5			0,394	43413055	43418055
8	13,00		1,5			0,432	43413063	43418063
10	14,00		1,0			0,326	43413078	43418078
10	14,00		1,5			0,470	43413080	43418080
10	15,00		1,0			0,350	43413086	43418086
10	15,00		1,5			0,507	43413087	43418087
10	15,00		2,0			0,537	43413088	43418088
10	16,00		1,0			0,376	43413093	43418093
10	16,00		1,5			0,545	43413095	43418095
15	18,00		1,5			0,620	43413125	43418125
15	18,00		2,0			0,801	43413126	43418126
15	20,00		1,5			0,695	43413140	43418140
15	20,00		2,0			0,901	43413142	43418142
20	22,00		1,5			0,770	43413168	43418168
20	22,00		2,0			1,000	43413169	43418169
20	25,00		1,5			0,883	43413199	43418199
20	25,00		2,0			1,152	43413201	43418201
25	28,00		1,5			0,995	43413240	43418240
25	28,00		2,0			1,302	43413241	43418241
25	30,00		1,5			1,070	43413258	43418258
25	30,00		2,0			1,402	43413259	43418259
32	35,00		2,0			1,653	43413321	43418321
32	38,00		2,0			1,803	43413338	43418338
32	40,00		2,0			1,903	43413363	43418363
40	44,50		2,0			2,128	43413404	43418404

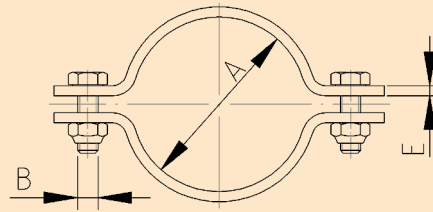

PIJPBEUGELSET ZWAAR ISO

DN / Inch	A	B	C	D	E	Kg	304	316
8 / 0,25"	13,5	M6			20x3		90233009	90236009
10 / 0,375"	17,2	M6			20x3		90233012	90236012
15 / 0,5"	21,3	M6			20x3		90233017	90236017
20 / 0,75"	26,9	M6			20x4		90233023	90236023
25 / 1"	33,7	M8			20x4		90233028	90236028
32 / 1,25"	42,4	M8			20x4		90233034	90236034
40 / 1,5"	48,3	M8			20x4		90233043	90236043
50 / 2"	60,3	M8			20x4		90233054	90236054
65 / 2,5"	76,1	M8			20x4		90233067	90236067
80 / 3"	88,9	M8			25x4		90233089	90236089
100 / 4"	114,3	M8			25x4		90233104	90236104
125 / 5"	139,7	M12			40x6		90233128	90236128
150 / 6"	168,3	M12			40x6		90233154	90236154
200 / 8"	219,1	M12			40x6		90233204	90236204

PIJPBEUGELSET ZWAAR METRISCH

DN	A	B	C	D	E	Kg	304	316
10	13,0	M6			20x3		90333001	90336001
15	19,0	M6			20x3		90333002	90336002
20	23,0	M6			20x4		90333003	90336003
25	29,0	M8			20x4		90333005	90336005
32	35,0	M8			20x4		90333007	90336007
40	41,0	M8			20x4		90333009	90336009
50	53,0	M8			20x4		90333011	90336011
65	70,0	M8			20x4		90333013	90336013
80	85,0	M8			25x4		90333015	90336015
100	104,0	M8			25x4		90333017	90336017
125	129,0	M12			40x6		90333019	90336019
150	154,0	M12			40x6		90333020	90336020
200	204,0	M12			40x6		90333021	90336021

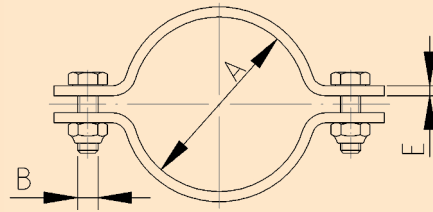

PIJPBEUGELSET LICHT ISO

DN / Inch	A	B	C	D	E	Kg	304	316
20 / 0,75"	26,9	M6x20			25x3		90233023MS	90236023MS
25 / 1"	33,7	M6x20			25x3		90233028MS	90236028MS
32 / 1,25"	42,4	M6x20			25x3		90233034MS	90236034MS
40 / 1,5"	48,3	M6x20			25x3		90233043MS	90236043MS
50 / 2"	60,3	M6x20			25x3		90233054MS	90236054MS
65 / 2,5"	76,1	M6x20			25x3		90233067MS	90236067MS
80 / 3"	88,9	M6x20			25x3		90233089MS	90236089MS
100 / 4"	114,3	M6x20			25x3		90233104MS	90236104MS
125 / 5"	139,7	M6x20			25x3		90233128MS	90236128MS

PIJPBEUGELSET LICHT METRISCH

DN	A	B	C	D	E	Kg	304
10	12,0			M6x20	20x2	0,030	90333001MS
15	18,0			M6x20	20x2	0,040	90333002MS
20	22,0			M6x20	20x3	0,060	90333003MS
25	28,0			M6x20	20x3	0,060	90333005MS
32	34,0			M6x20	20x3	0,080	90333007MS
40	40,0			M6x20	20x3	0,080	90333009MS
50	52,0			M6x20	20x3	0,100	90333011MS
65	70,0			M6x20	20x3	0,130	90333013MS
80	85,0			M6x20	25x3	0,190	90333015MS
100	104,0			M6x20	25x3	0,240	90333017MS
125	129,0			M8x27	30x3	0,370	90333019MS
150	154,0			M8x27	30x3	0,420	90333020MS
200	204,0			M10x40	40x4	0,000	90333021MS

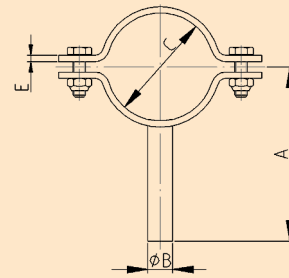
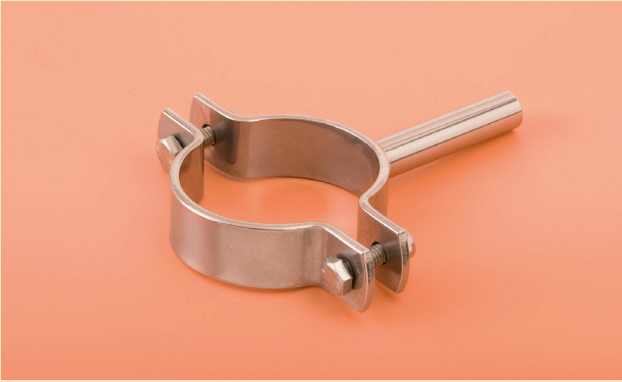

PIJPBEUGELSET OP STIFT ISO

DN / Inch	A	B	C	D	E	Kg	304
20 / 0,75"	71,0	10,0	26,9		25x3		90233323MS
25 / 1"	74,5	10,0	33,7		25x3		90233328MS
32 / 1,25"	79,0	10,0	42,4		25x3		90233334MS
40 / 1,5"	82,0	10,0	48,3		25x3		90233343MS
50 / 2"	88,0	12,0	60,3		25x3		90233354MS
65 / 2,5"	95,5	12,0	76,1		25x3		90233364MS
80 / 3"	102,0	12,0	88,9		25x3		90233389MS
100 / 4"	115,0	12,0	114,3		25x3		90233404MS

PIJPBEUGELSET OP STIFT METRISCH

DN	A	B	C	D	E	Kg	304
10	62,5	8,0	12,0		20x2	0,060	90333026MS
15	65,5	8,0	18,0		20x2	0,070	90333027MS
20	68,5	8,0	22,0		20x3	0,090	90333028MS
25	71,5	10,0	28,0		20x3	0,110	90333030MS
32	74,5	10,0	34,0		20x3	0,120	90333032MS
40	77,5	10,0	40,0		20x3	0,130	90333034MS
50	83,5	12,0	52,0		20x3	0,160	90333036MS
65	92,5	12,0	70,0		20x3	0,190	90333038MS
80	100,0	12,0	85,0		25x3	0,250	90333040MS
100	109,5	12,0	104,0		25x3	0,290	90333042MS
125	140,5	16,0	129,0		30x3	0,510	90333044MS
150	179,5	16,0	154,0		30x3	1,035	90333045MS
200	226,0	20,0	204,0		40x4	0,000	90333046MS

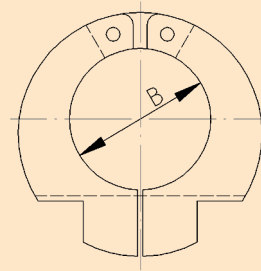
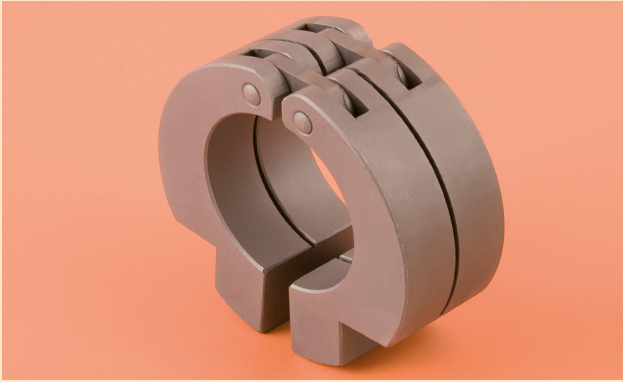
**ZAAGBLOK**

DN / Inch	A	B	C	D	E	Kg	SKS nr.
15		18,0				0,550	90902752
0,5"		21,3				0,530	90902776
20		22,0				0,530	90902753
0,75"		26,9				0,530	90902777
25		28,0				0,710	90902755
1"		33,7				0,640	90902778
32		34,0				0,640	90902757
1,25"		42,4				0,830	90902779
40		40,0				0,830	90902759
1,5"		48,3				0,830	90902780
50		52,0				0,980	90902761
50		54,0				0,980	90902769
2"		60,3				0,980	90902781
65		70,0				1,940	90902763
2,5"		76,1				1,940	90902764
80		85,0				2,150	90902765
3"		88,9				2,150	90902782
100		104,0				2,690	90902767
4"		114,3				2,690	90902783



Voorgeïsoleerde leidingen

De enorme voordelen van voorgeïsoleerde leidingsystemen in combinatie met onze kennis van procesleidingen, staan garant voor een optimaal uitgangspunt voor uw procesleiding. De mogelijkheden zijn vrijwel onbeperkt binnen een bereik van -200°C tot $+350^{\circ}\text{C}$. Vooral in leidingbruggen kunt u enorme winst maken op gebied van investeringskosten, installatietijd en vooral ook energiekosten.

Mix van 4 variabele componenten

1. **Transportleiding:** iedere materiaal soort tot een diameter van ca. 800 mm
2. **Isolatie:** Op maat gekozen materiaal op basis van toepassing temperatuur
3. **Buitenmantel:** Keuze uit 5 robuuste materiaal soorten
4. **Optie's:** Diverse mogelijkheden zoals tracing, lekdetectie etc.

De combinatie van deze de gekozen variabelen vormen de meest optimale configuratie voor uw toepassing. De keuze van de samenstelling wordt bepaald op basis van technische en economische input.

Kenmerken

- 100% waterdicht
- Hoge mechanische bestendigheid
- Effectieve corrosie bescherming van de leiding
- Chemisch en UV resistent
- Tracing van de leiding is mogelijk
- Beugeling van de leiding om de buitenmantel
- Eenvoudige montage

Voordelen



- Goed reinigbaar
- Constante isolatiewaarde totale levensduur
- Snelle terugverdientijd
- Geen besmettingsbron
- Minder energieverlies
- Lage onderhoudskosten

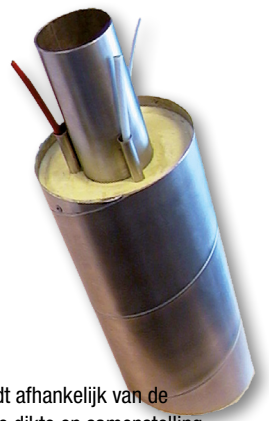

Levering op maat

Iedere toepassing staat op zichzelf. Daarom wordt afhankelijk van de temperatuur en het gewenste isolatieresultaat, de dikte en samenstelling van de isolatie per toepassing berekend. Dit kan zelfs aangevuld worden met specifieke wensen. Het systeem heeft natuurlijk ook zijn beperkingen maar die wegen niet op tegen de enorme voordelen. Naast de mogelijkheid voor standaard leiding componenten kan S.K.S. ook korte leidingtrajecten, skids, koppelstukken of machineonderdelen voor u isoleren of vanaf tekening zelfs voor u produceren.

Waarom zou u achteraf laten isoleren als het vooraf in een optimale situatie beter gedaan kan.



Lasfittingen

Aanvullend op de buis normen zijn er ook de aansluitende normen voor de diverse lasfittingen. In iedere reeks is er een directe link tussen deze normen en zijn daarmee aanvullend op elkaar.

In de praktijk worden de diverse normen door elkaar heen verwerkt en daarom lijkt deze artikelgroep niet uniform. Een vaste uitvoering van een bocht, T-stuk of andere lasfitting is wel degelijk mogelijk.

De actuele normen EN 10253-3 en EN 10253-4, gebruikt S.K.S. als standaard, maar de andere uitvoeringen zijn natuurlijk ook mogelijk.

De Norm EN 10253-4 heeft een directe link met EN 10217-7 en de PED. (Pressure Equipment Directive 97/23/EC)

Uitvoeringen

Bochten kort in 45° en 90° > Radius 1,5D, 2D, 3D 5D of D+100

(voorheen DIN 2605)

T-stukken lang en kort in symmetrisch en verlopende uitvoering

(voorheen DIN 2615)

Verlopen conisch en excentrisch (voorheen DIN 2616)

Eindcaps (voorheen DIN 2617)

Boordringen (laskraag)

Maatreeks en werkstof

Maten volgens bovenstaand bij de buismaten genoemde normen

Materiaal volgens EN 10088-1

Toleranties en specificaties

Volgens DIN ISO 2468-1, ISO2768-c, DIN 2609 tbl.5 en DIN 6784

Certificaten

3.1 certificaat Volgens EN 10204 (2.2 of 3.2 certificaat ook mogelijk op aanvraag)

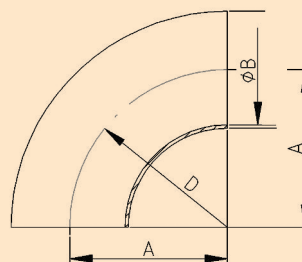

LASBOCHT 90° ISO

DN / Inch	A	B	C	D	E	Kg	304L	316L
10 / 0,375"	28,0	17,20	1,6	28,0		0,03	46134109	46138109
10 / 0,375"	28,0	17,20	2,3	28,0		0,04	46134112	46138112
15 / 0,5"	27,5	21,30	1,6	27,5		0,03	46134158	46138158
15 / 0,5"	27,5	21,30	2,0	27,5		0,04	46134159	46138159
15 / 0,5"	27,5	21,30	2,6	27,5		0,06	46134161	46138161
20 / 0,75"	28,5	26,90	1,6	28,5		0,05	46134222	46138222
20 / 0,75"	28,5	26,90	2,0	28,5		0,06	46134223	46138223
20 / 0,75"	28,5	26,90	2,6	28,5		0,08	46134225	46138225
25 / 1"	38,0	33,70	1,6	38,0		0,08	46134295	46138295
25 / 1"	38,0	33,70	2,0	38,0		0,10	46134296	46138296
25 / 1"	38,0	33,70	2,6	38,0		0,12	46134299	46138299
25 / 1"	38,0	33,70	3,2	38,0		0,14	46134302	46138302
32 / 1,25"	47,5	42,40	2,0	47,5		0,14	46134383	46138383
32 / 1,25"	47,5	42,40	2,6	47,5		0,16	46134385	46138385
32 / 1,25"	47,5	42,40	3,2	47,5		0,19	46134388	46138388
40 / 1,5"	57,0	48,30	1,6	57,0		0,19	46134427	46138427
40 / 1,5"	57,0	48,30	2,0	57,0		0,22	46134428	46138428
40 / 1,5"	57,0	48,30	2,6	57,0		0,26	46134431	46138431
40 / 1,5"	57,0	48,30	3,2	57,0		0,32	46134434	46138434

vervolg tabel op pag. 17

vervolg tabel van pag. 16

DN / Inch	A	B	C	D	E	Kg	304L	316L
50 / 2"	76,0	60,30	2,0	76,0		0,29	46134519	46138519
50 / 2"	76,0	60,30	2,6	76,0		0,34	46134521	46138521
50 / 2"	76,0	60,30	3,6	76,0		0,62	46134525	46138525
65 / 2,5"	95,0	76,10	2,0	95,0		0,62	46134594	46138594
65 / 2,5"	95,0	76,10	3,0	95,0		0,80	46134599	46138599
65 / 2,5"	95,0	76,10	3,6	95,0		1,08	46134601	46138601
80 / 3"	114,0	88,90	2,0	114,0		0,81	46134640	46138640
80 / 3"	114,0	88,90	2,6	114,0		1,02	46134643	46138643
80 / 3"	114,0	88,90	3,2	114,0		1,15	46134646	46138646
100 / 4"	152,0	114,30	2,0	152,0		1,30	46134722	46138722
100 / 4"	152,0	114,30	2,6	152,0		1,60	46134724	46138724
100 / 4"	152,0	114,30	3,0	152,0		2,00	46134726	46138726
125 / 5"	190,0	139,70	2,0	190,0		2,10	46134774	46138774
125 / 5"	190,0	139,70	2,6	190,0		2,56	46134777	46138777
125 / 5"	190,0	139,70	3,0	190,0		3,08	46134779	46138779
150 / 6"	229,0	168,30	2,0	229,0		2,84	46134807	46138807
150 / 6"	229,0	168,30	2,6	229,0		3,75	46134810	46138810
150 / 6"	229,0	168,30	3,0	229,0		4,90	46134812	46138812
200 / 8"	305,0	219,10	2,0	305,0		5,15	46134848	46138848
200 / 8"	305,0	219,10	2,6	305,0		6,20	46134851	46138851
200 / 8"	305,0	219,10	3,0	305,0		7,90	46134853	46138853

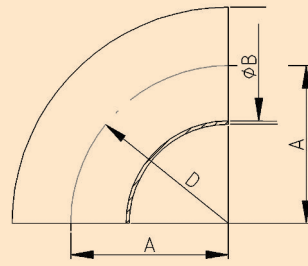

LASBOCHT 90° / BAUART 3 METRISCH

DN / MM	A	B	C	D	E	Kg	304L	316L
10 / 12	30,0	12,00	1,0	30,0		0,03	46134052	46138052
10 / 15	27,5	15,00	1,5	50,0		0,07	46134087	46138087
15 / 18	22,5	18,00	1,5	22,5		0,03	46134125	46138125
15 / 20	25,0	20,00	1,5	25,0		0,03	46134140	46138140
15 / 20	25,0	20,00	2,0	25,0		0,04	46134142	46138142
20 / 23	25,0	23,00	1,5	25,0		0,04	46134180	46138180
20 / 25	27,5	25,00	1,0	27,5		0,04	46134200	46138200
20 / 25	27,5	25,00	1,5	27,5		0,05	46134202	46138202
20 / 25	27,5	25,00	2,0	27,5		0,05	46134201	46138201
25 / 28	32,5	28,00	1,5	32,5		0,06	46134240	46138240
25 / 30	33,5	30,00	2,0	33,5		0,08	46134259	46138259
25 / 32	35,0	32,00	2,0	35,0		0,10	46134260	46138260
32 / 35	45,0	35,00	2,0	45,0		0,12	46133321	46136321
32 / 40	45,0	40,00	1,5	45,0		0,14	46134362	46138362
32 / 40	45,0	40,00	2,0	45,0		0,16	46134363	46138363
40 / 44,5	51,0	44,50	2,0	51,0		0,17	46133404	46136404
50 / 51	67,5	51,00	1,5	67,5		0,21	46134475	46138475
50 / 53	72,5	53,00	1,5	72,5		0,26	46134480	46138480
50 / 54	70,0	54,00	2,0	70,0		0,34	46134482	46138482
50 / 57	75,0	57,00	2,0	75,0		0,34	46134495	46138495
50 / 57	75,0	57,00	3,0	75,0		0,48	46134500	46138500
65 / 70	92,0	70,00	2,0	92,0		0,50	46134566	46138566
80 / 84	105,0	84,00	2,0	105,0		0,75	46134630	46138630
100 / 104	150,0	104,00	2,0	150,0		1,20	46134694	46138694
125 / 129	187,5	129,00	2,0	187,5		1,90	46134754	46138754
150 / 154	225,0	154,00	2,0	225,0		2,75	46134790	46138790
150 / 156	225,0	156,00	3,0	225,0		4,05	46134794	46138794
200 / 204	300,0	204,00	2,0	300,0		4,75	46134834	46138834
250 / 254	375,0	254,00	2,0	375,0		7,50	46134867	46138867
250 / 256	375,0	256,00	3,0	375,0		10,85	46134871	46138871
300 / 304	450,0	304,00	2,0	450,0		10,00	46134901	46138901
300 / 306	450,0	306,00	3,0	450,0		16,10	46134905	46138905
350 / 356	533,0	356,00	3,0	533,0		22,00	46134940	46138940
400 / 406	610,0	406,00	3,0	610,0		29,00	46134944	46138944
500 / 506	762,0	506,00	3,0	762,0		45,00	46134966	46138966
600 / 606	914,0	606,00	3,0	914,0		82,00	46134969	46138969

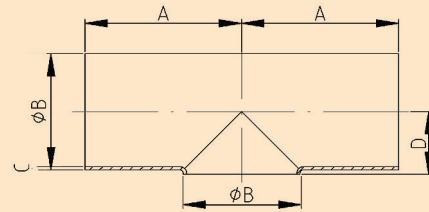
**T-STUK KORT EN 10253 ISO**

DN / Inch	A	B	C	D	E	Kg	304L	316L
10 / 0,375"	25,0	17,20	1,6	10,6		0,04	49134150	49138150
15 / 0,5"	27,5	21,30	1,6	12,7		0,07	49134158	49138158
15 / 0,5"	27,5	21,30	2,0	12,7		0,07	49134159	49138159
15 / 0,5"	27,5	21,30	2,6	12,7		0,07	49134161	49138161
20 / 0,75"	28,5	26,90	1,6	15,5		0,09	49134222	49138222
20 / 0,75"	28,5	26,90	2,0	15,5		0,09	49134223	49138223
20 / 0,75"	28,5	26,90	2,6	15,5		0,09	49134225	49138225
25 / 1"	38,0	33,70	2,0	18,9		0,15	49134296	49138296
25 / 1"	38,0	33,70	2,6	18,9		0,16	49134299	49138299
25 / 1"	38,0	33,70	3,2	18,9		0,17	49134302	49138302
32 / 1,25"	47,5	42,40	2,0	23,2		0,24	49134383	49138383
32 / 1,25"	47,5	42,40	2,6	23,2		0,25	49134385	49138385
32 / 1,25"	47,5	42,40	3,2	23,2		0,26	49134388	49138388
40 / 1,5"	57,0	48,30	2,0	26,2		0,34	49134428	49138428
40 / 1,5"	57,0	48,30	2,6	26,2		0,35	49134431	49138431
40 / 1,5"	57,0	48,30	3,0	26,2		0,36	49134433	49138433
50 / 2"	64,0	60,30	2,0	33,2		0,50	49134519	49138519
50 / 2"	64,0	60,30	2,6	33,2		0,51	49134521	49138521
50 / 2"	64,0	60,30	3,6	33,2		0,52	49134525	49138525
65 / 2,5"	76,0	76,10	2,0	42,1		0,70	49134594	49138594
65 / 2,5"	76,0	76,10	2,9	42,1		0,71	49134598	49138598
80 / 3"	86,0	88,90	2,0	49,5		0,90	49134640	49138640
80 / 3"	86,0	88,90	2,6	49,5		0,92	49134643	49138643
80 / 3"	86,0	88,90	3,0	49,5		0,94	49134645	49138645
100 / 4"	105,0	114,30	2,0	64,2		1,40	49134722	49138722
100 / 4"	105,0	114,30	2,6	64,2		1,70	49134724	49138724
100 / 4"	105,0	114,30	3,0	64,2		2,10	49134726	49138726
125 / 5"	124,0	139,70	2,0	77,9		3,00	49134774	49138774
125 / 5"	124,0	139,70	2,6	77,9		3,30	49134777	49138777
125 / 5"	124,0	139,70	3,0	77,9		3,50	49134779	49138779
150 / 6"	143,0	168,30	2,0	94,2		4,10	49134808	49138808
150 / 6"	143,0	168,30	2,6	94,2		4,10	49134810	49138810
150 / 6"	143,0	168,30	3,0	94,2		4,80	49134812	49138812
200 / 8"	178,0	219,10	2,0	121,6		6,00	49134848	49138848
200 / 8"	178,0	219,10	2,9	121,6		6,60	49134852	49138852
250 / 10"	216,0	273,00	3,0	151,5		10,00	49134864	49138864
300 / 12"	254,0	323,90	3,0	177,0		15,00	49134918	49138918

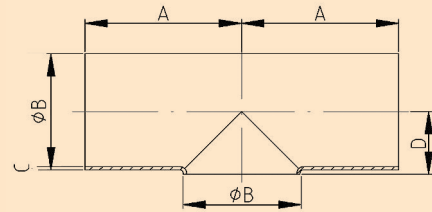

T-STUK KORT DIN 2615 METRISCH

DN / MM	A	B	C	D	E	Kg	304L	316L
15 / 20	25,0	20,00	2,0	12,0		0,08	49134142	49138142
20 / 25	23,0	25,00	2,0	14,5		0,10	49134201	49138201
25 / 30	33,0	30,00	2,0	17,0		0,10	49134259	49138259
40 / 44,5	60,0	44,50	2,0	25,3		0,32	49133404	49136404
50 / 54	73,0	54,00	2,0	30,0		0,48	49134482	49138482
50 / 57	76,0	57,00	2,0	31,5		0,50	49134495	49138495
65 / 70	80,0	70,00	2,0	38,0		0,79	49134566	49138566
80 / 84	80,0	84,00	2,0	47,0		1,10	49134630	49138630
100 / 104	90,0	104,00	2,0	59,0		1,39	49134694	49138694
125 / 129	115,0	129,00	2,0	72,5		2,24	49134754	49138754
150 / 154	135,0	154,00	2,0	87,0		4,40	49134790	49138790
150 / 156	135,0	156,00	3,0	88,0		4,60	49134794	49138794
200 / 204	175,0	204,00	2,0	114,0		7,50	49134834	49138834
250 / 254	216,0	254,00	2,0	140,0		10,90	49134867	49138867
250 / 256	216,0	256,00	3,0	142,0		11,50	49134871	49138871
300 / 304	254,0	304,00	2,0	167,0		12,40	49134901	49138901
300 / 306	254,0	306,00	3,0	168,0		13,10	49134905	49138905

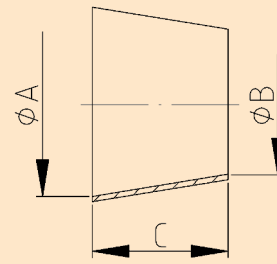

LASVERLOOP CONCENTRISCH EN 10253 ISO

DN	A	B	C	D	E	Kg	304L	316L
15 x 8	21,3	13,5	12,0			0,04	48134002	48138002
20 x 10	26,9	17,2	29,0			0,08	48134009	48138009
20 x 15	26,9	21,3	17,0			0,08	48134013	48138013
25 x 10	33,7	17,2	50,0			0,10	48134030	48138030
25 x 15	33,7	21,3	37,0			0,10	48134032	48138032
25 x 20	33,7	26,9	20,0			0,10	48134040	48138040
32 x 15	42,4	21,3	63,0			0,10	48134060	48138060
32 x 20	42,4	26,9	46,0			0,10	48134066	48138066
32 x 25	42,4	33,7	26,0			0,10	48134074	48138074
40 x 20	48,3	26,9	63,0			0,10	48134102	48138102
40 x 25	48,3	33,7	43,0			0,10	48134104	48138104
40 x 32	48,3	42,4	17,0			0,10	48134111	48138111
50 x 15	60,3	21,3	117,0			0,20	48134134	48138134
50 x 20	60,3	26,9	99,0			0,20	48134135	48138135
50 x 25	60,3	33,7	79,0			0,20	48134138	48138138
50 x 32	60,3	42,4	53,0			0,20	48134147	48138147
50 x 40	60,3	48,3	36,0			0,20	48134154	48138154
65 x 25	76,1	33,7	126,0			0,20	48134204	48138204
65 x 32	76,1	42,4	100,0			0,20	48134206	48138206
65 x 40	76,1	48,3	82,0			0,20	48134208	48138208
65 x 50	76,1	60,3	47,0			0,30	48134221	48138221
80 x 40	88,9	48,3	120,0			0,30	48134265	48138265
80 x 50	88,9	60,3	85,0			0,30	48134267	48138267
80 x 65	88,9	76,1	38,0			0,30	48134279	48138279
100 x 40	114,3	48,3	195,0			0,60	48134330	48138330
100 x 50	114,3	60,3	160,0			0,60	48134332	48138332
100 x 65	114,3	76,1	113,0			0,50	48134341	48138341
100 x 80	114,3	88,9	75,0			0,50	48134352	48138352
125 x 50	139,7	60,3	235,0			1,10	48134390	48138390
125 x 65	139,7	76,1	188,0			1,10	48134391	48138391
125 x 80	139,7	88,9	151,0			1,10	48134401	48138401
125 x 100	139,7	114,3	75,0			1,10	48134412	48138412
150 x 80	168,3	88,9	235,0			1,10	48134466	48138466
150 x 100	168,3	114,3	160,0			1,00	48134467	48138467
150 x 125	168,3	139,7	85,0			1,10	48134468	48138468

DN	A	B	C	D	E	Kg	304L	316L
200 x 100	219,1	114,3	310,0			2,30	48134498	48138498
200 x 125	219,1	139,7	235,0			2,20	48134500	48138500
200 x 150	219,1	168,3	150,0			2,00	48134501	48138501
250 x 200	273,0	219,1	160,0			3,30	48134510	48138510
250 x 150	273,0	168,3	310,0			2,20	48134511	48138511
300 x 250	323,9	273,0	151,0			8,40	48134516	48138516

LASVERLOOP CONCENTRISCH EN 10253 METRISCH

DN	A	B	C	D	E	Kg	304L	316L
25 x 20	25,0	20,0	15,0			0,01	48133070	48136070
28 x 20	28,0	20,0	24,0			0,02	48133080	48136080
30 x 20	30,0	20,0	30,0			0,03	48133099	48139099
30 x 25	30,0	25,0	15,0			0,02	48133100	48136100
40 x 28	40,0	28,0	36,0			0,05	48133115	48136115
44 x 30	44,0	30,0	42,0			0,09	48133120	48136120
54 x 25	54,0	25,0	87,0			0,17	48133127	48136127
54 x 30	54,0	30,0	72,0			0,16	48133129	48136129
54 x 34	54,0	34,0	60,0			0,13	48133131	48136131
54 x 40	54,0	40,0	42,0			0,09	48133130	48136130
54 x 44	54,0	44,0	30,0			0,07	48133132	48136132
69 x 44	69,0	44,0	75,0			0,29	48133170	48136170
70 x 54	70,0	54,0	48,0			0,15	48133172	48136172
84 x 44	84,0	44,0	120,0			0,48	48133234	48136234
84 x 54	84,0	54,0	60,0			0,38	48133236	48136236
104 x 54	104,0	54,0	150,0			0,60	48133295	48136295
104 x 69	104,0	69,0	105,0			0,50	48133299	48136299
104 x 84	104,0	84,0	60,0			0,30	48133300	48136300
129 x 54	129,0	54,0	225,0			1,10	48133361	48136361
129 x 84	129,0	84,0	135,0			0,90	48133364	48136364
129 x 104	129,0	104,0	75,0			0,50	48133365	48136365
154 x 84	154,0	84,0	210,0			1,30	48133421	48136421
154 x 104	154,0	104,0	150,0			1,00	48133422	48136422
154 x 129	154,0	129,0	75,0			0,60	48133423	48136423
204 x 104	204,0	104,0	300,0			2,40	48133479	48136479
204 x 129	204,0	129,0	225,0			2,00	48133480	48136480
204 x 154	204,0	154,0	150,0			1,40	48133481	48136481
254 x 129	254,0	129,0	375,0			3,60	48133543	48136543
254 x 154	254,0	154,0	300,0			3,20	48133544	48136544
254 x 204	254,0	204,0	150,0			1,80	48133545	48136545
304 x 154	304,0	154,0	450,0			5,20	48133614	48136614
304 x 204	304,0	204,0	300,0			3,90	48133615	48136615
304 x 254	304,0	254,0	150,0			2,10	48133616	48136616
356 x 306	356,0	306,0	150,0			3,70	48133656	48136656

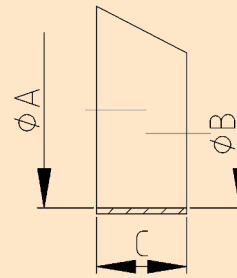

LASVERLOOP EC EXCENTRISCH EN10253 ISO

DN	A	B	C	D	E	Kg	304L	316L
20 x 10	26,9	17,2	29,0			0,08	48234009	48238009
20 x 15	26,9	21,3	17,0			0,08	48234013	48238013
25 x 10	33,7	17,2	50,0			0,10	48234030	48238030
25 x 15	33,7	21,3	37,0			0,10	48234032	48238032
25 x 20	33,7	26,9	20,0			0,10	48234040	48238040
32 x 15	42,4	21,3	63,0			0,10	48234060	48238060
32 x 20	42,4	26,9	46,0			0,10	48234066	48238066
32 x 25	42,4	33,7	26,0			0,10	48234074	48238074
40 x 20	48,3	26,9	63,0			0,10	48234102	48238102
40 x 25	48,3	33,7	43,0			0,10	48234104	48238104
40 x 32	48,3	42,4	17,0			0,10	48234111	48238111
50 x 15	60,3	21,3	117,0			0,20	48234134	48238134
50 x 20	60,3	26,9	99,0			0,20	48234135	48238135
50 x 25	60,3	33,7	79,0			0,20	48234138	48238138
50 x 32	60,3	42,4	53,0			0,20	48234147	48238147
50 x 40	60,3	48,3	36,0			0,20	48234154	48238154
65 x 25	76,1	33,7	126,0			0,20	48234204	48238204
65 x 32	76,1	42,4	100,0			0,20	48234206	48238206
65 x 40	76,1	48,3	82,0			0,20	48234208	48238208
65 x 50	76,1	60,3	47,0			0,30	48234221	48238221
80 x 40	88,9	48,3	120,0			0,30	48234265	48238265
80 x 50	88,9	60,3	85,0			0,30	48234267	48238267
80 x 65	88,9	76,1	38,0			0,30	48234279	48238279
100 x 40	114,3	48,3	195,0			0,60	48234330	48238330
100 x 50	114,3	60,3	160,0			0,60	48234332	48238332
100 x 65	114,3	76,1	113,0			0,50	48234341	48238341
100 x 80	114,3	88,9	75,0			0,50	48234352	48238352
125 x 50	139,7	60,3	235,0			1,10	48234390	48238390
125 x 65	139,7	76,1	188,0			1,10	48234391	48238391
125 x 80	139,7	88,9	151,0			1,10	48234401	48238401
125 x 100	139,7	114,3	75,0			1,10	48234412	48238412
150 x 80	168,3	88,9	235,0			1,10	48234466	48238466
150 x 100	168,3	114,3	160,0			1,00	48234467	48238467
150 x 125	168,3	139,7	85,0			1,10	48234468	48238468
200 x 100	219,1	114,3	310,0			2,30	48234498	48238498

DN	A	B	C	D	E	Kg	304L	316L
200 x 125	219,1	139,7	235,0			2,20	48234500	48238500
200 x 150	219,1	168,3	150,0			2,00	48234501	48238501
250 x 200	273,0	219,1	160,0			3,30	48234510	48238510
250 x 150	273,0	168,3	310,0			2,20	48234511	48238511
300 x 250	323,9	273,0	151,0			8,40	48234516	48238516

LASVERLOOP EC EXCENTRISCH EN 10253 METRISCH

DN	A	B	C	D	E	Kg	304L	316L
30 x 20	30,0	20,0	30,0			0,03	48233099	48236099
30 x 25	30,0	25,0	15,0			0,02	48233100	48236100
44 x 30	44,0	30,0	42,0			0,09	48233120	48236120
54 x 30	54,0	30,0	72,0			0,16	48233129	48236129
54 x 44	54,0	44,0	30,0			0,07	48233132	48236132
69 x 44	69,0	44,0	75,0			0,29	48233170	48236170
70 x 54	70,0	54,0	48,0			0,15	48233172	48236172
84 x 44	84,0	44,0	120,0			0,48	48233234	48236234
84 x 54	84,0	54,0	60,0			0,38	48233236	48236236
104 x 54	104,0	54,0	150,0			0,60	48233295	48236295
104 x 69	104,0	69,0	105,0			0,50	48233299	48236299
104 x 84	104,0	84,0	60,0			0,30	48233300	48236300
129 x 54	129,0	54,0	225,0			1,10	48233361	48236361
129 x 84	129,0	84,0	135,0			0,90	48233364	48236364
129 x 104	129,0	104,0	75,0			0,50	48233365	48236365
154 x 84	154,0	84,0	210,0			1,30	48233421	48236421
154 x 104	154,0	104,0	150,0			1,00	48233422	48236422
154 x 129	154,0	129,0	75,0			0,60	48233423	48236423
204 x 104	204,0	104,0	300,0			2,40	48233479	48236479
204 x 129	204,0	129,0	225,0			2,00	48233480	48236480
204 x 154	204,0	154,0	150,0			1,40	48233481	48236481
254 x 129	254,0	129,0	375,0			3,60	48233543	48236543
254 x 154	254,0	154,0	300,0			3,20	48233544	48236544
254 x 204	254,0	204,0	150,0			1,80	48233545	48236545
304 x 154	304,0	154,0	450,0			5,20	48233614	48236614
304 x 204	304,0	204,0	300,0			3,90	48233615	48236615
304 x 254	304,0	254,0	150,0			2,10	48233616	48236616
356 x 306	356,0	306,0	150,0			3,70	48233656	48236656



Pipetite® de hygiënische wanddoorvoer

Optisch en Hygiënisch zijn de huidige oplossingen voor muurdoorvoeringen een doorn in het oog. Ze zijn vaak niet mooi afgewerkt, sluiten niet goed, zijn niet flexibel en zeker nooit uniform. Met het Pipetite® programma heeft S.K.S. de oplossing voor dit probleem.

De Pipetite® wanddoorvoeringen zijn ontwikkeld op basis van bovenstaande tekortkomingen in de praktijk en daardoor passen ze in iedere omgeving. Alle uitvoeringen zijn self-sealing, flexibel, hygiënisch verantwoord en zeer eenvoudig aan te monteren.

Pipetite® eigenschappen zijn simpel en doelmatig

- 6 uitvoeringen voor buis van 5 tot 380 mm diameter
- Hygiënisch wit Siliconen met RVS 316 flens
- Volledig self-sealing (geen extra sealant nodig)
- Flexibel om beweging op te vangen
- Siliconen omsluit de buis waterdicht
- Bestand tot 260°C (mediumbuis)
- Snelle montage zonder restafval
- Geen onderhoud en een lange levensduur
- PipeTite en Grommets zijn IP34 gekeurd.
- Mini Grommets zijn NEMA gekeurd.

Pipetite is leverbaar als **wanddoorvoer** (Pipetite® en ReBoot®), **buisdoorvoer** (Pipe n Pipe®) of **plaatdoorvoer** (Tube Grommets en Hose grommets)

Pipetite® is toepasbaar in veel voorkomende situaties. De aansluiting om de buis is voor alle uitvoeringen gelijk. U snijdt het hoedje op maat en schuift de wanddoorvoer over de buis. In geval van de ReBoot® plaatst u de doorvoering eenvoudig om de bestaande situatie en sluit u de ReBoot® met een klem.

PIPETITE.



De aansluiting op het gat waar de buis doorheen gevoerd wordt, is voor iedere uitvoering anders.

- De Pipetite® en de ReBoot® zijn eenvoudig op de wand of plafond te monteren.
- De Pipe n Pipe® is gemaakt voor een buisdoorvoer van 4"/DN100 of 6"/DN150.
- Grommets zijn er voor buis of slangdoorvoering door een machinewand of RVS muurplaat tot 3 mm dikte. Multi uitvoering is verkrijgbaar.
- Flat is een vlakke uitvoering voor tankwand of muurafdekplaat.

Indien u assistentie verlangt bij het kiezen van de juiste wanddoorvoer, staan wij u graag te woord.

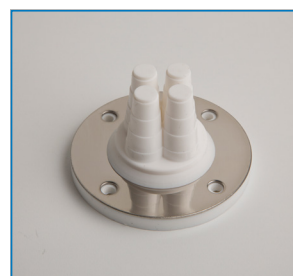
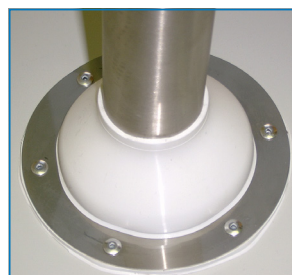

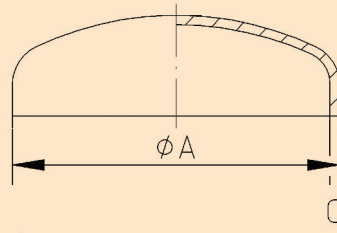
**EINDKAP ISO**

DN	ISO	A	B	C	D	E	Kg	304(L)	316L
15	0,5"	21,30		2,00			0,020	60134159	60138159
20	0,75"	26,90		2,00			0,030	60134223	60138223
25	1"	33,70		2,00			0,030	60134296	60138296
32	1,25"	42,40		2,00			0,040	60134383	60138383
40	1,5"	48,30		2,00			0,050	60134428	60138428
50	2"	60,30		2,00			0,090	60134519	60138519
65	2,5"	76,10		2,00			0,160	60134594	60138594
80	3"	88,90		2,00			0,230	60134640	60138640
100	4"	114,30		2,00			0,460	60134722	60138722
125	5"	139,70		2,00			0,490	60134774	60138774
150	6"	168,30		2,00			0,880	60134807	60138807
200	8"	219,10		2,00			1,250	60134848	60138848
250	10"	273,00		3,00			2,300	60134881	60138881

EINDKAP METRISCH

DN	ISO	A	B	C	D	E	Kg	304(L)	316L
40		44,50		2,00			0,040	60134404	60138404
50		54,00		2,00			0,060	60134482	60138482
50		57,00		2,00			0,060	60134495	60138495
65		70,00		2,00			0,100	60134566	60138566
80		84,00		2,00			0,130	60134630	60138630
100		104,00		2,00			0,200	60134694	60138694
125		129,00		2,00			0,400	60134754	60138754
150		154,00		2,00			0,550	60134790	60138790
150		156,00		3,00			0,600	60134794	60138794
200		204,00		2,00			0,970	60134834	60138834
250		254,00		2,00			1,650	60134867	60138867
300		306,00		3,00			2,500	60134905	60138905

DIN 11851 Koppeling

De zogenaamde "Melkkoppeling" volgens DIN 11851 is de meest toegepaste schroefkoppeling binnen de voedingsmiddelen industrie. De ronde draad en de grote toleranties zorgen ervoor dat de koppeling in praktijk altijd dicht te krijgen is. Desnoods met een verhoogde afdichting. Dit is echter niet meer geheel van deze tijd, maar het geeft wel aan dat de koppeling heel gebruiksvriendelijk is en waarschijnlijk daarom ook zo populair. De koppeling is officieel alleen in de NW maten genormeerd, maar er zijn wel uitvoeringen voor duimse- of ISO maten verkrijgbaar. Heel veel appendages of instrumenten zijn voorzien van een koppeldeel volgens DIN 11851.

Maatreeks en materiaal

volgens DIN 11851 behalve de lasaansluiting. Deze is gebaseerd op de inch maten. Men dient volgens de norm gesmeed vormmateriaal te gebruiken, er zijn echter veel gegoten koppelingen in de handel verkrijgbaar.

Toleranties en specificaties:

DIN 405-1 en 2, DIN 11887, DIN ISO 2768-1, ISO 48, FDA en BGA
Uitvoeringen en codes:

Puntstuk D, Draadstuk C, wartel F en afdichting G;
inwendige Ra waarde < 1,6µm
Aansluiting: Las (S), kort (SK), Wals (W)
Overige aansluitingen niet genormeerd:
Blind, Slangtule, inschroef of opschroef

Afdichtingen

EPDM, FKM (Viton), HNBR, MVQ (siliconen), NBR of PTFE (Teflon)

Druktoepassing (tot 140°C):

DN10 – DN40	max. 40 bar
DN50 – DN100	max. 25 bar
DN125 – DN150	max. 16 bar
DN200	max. 10 bar

Bijzonderheden

EHEGD keur indien voorzien van S.K.S. afdichting of in combinatie met het S.K.S. puntstuk en afdichting.

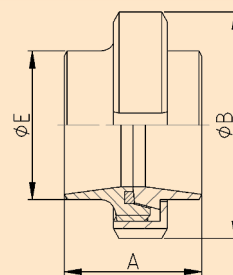

LASKOPPELING DIN 11851 ISO

DN / ISO	A	B	C	D	E	Kg	304L / NBR	316L / NBR
10 / 17,2	34,0	38,0			17,2	0,130	14734201	14738201
15 / 21,3	34,0	44,0			21,3	0,160	14734202	14738202
20 / 26,9	36,0	54,0			26,9	0,290	14734203	14738203
25 / 33,7	45,0	63,0			33,7	0,400	14734205	14738205
32 / 42,4	51,0	70,0			42,4	0,490	14734207	14738207
40 / 48,3	53,0	78,0			48,3	0,610	14734209	14738209
50 / 60,3	57,0	92,0			60,3	0,860	14734211	14738211
65 / 76,1	65,0	112,0			76,1	1,130	14734213	14738213
80 / 88,9	75,0	127,0			88,9	1,800	14734215	14738215
100 / 114,3	89,0	148,0			114,3	2,460	14734217	14738217
125 / 139,7	70,0	178,0			139,7	1,800	14734219	14738219
150 / 168,3	76,0	210,0			168,3	2,460	14734220	14738220

Draadfittingen / koppelingen

De zogenaamde gasdraadfittingen of BSP fittingen worden in verschillende uitvoeringen op de markt gebracht. De meest actuele norm voor de inbouwmaten van deze fittingen is de ISO 4144. In deze norm worden minimale maten genoemd. Iedere fabrikant is daarmee vrij om een eigen uitvoering te produceren met een minimale waarde. Gasdraadfittingen kunnen geproduceerd worden uit gegoten, gerold of gesmeed materiaal geproduceerd worden mits het eindproduct aan de gevraagde testwaarden voldoet. De betreffende draad wordt getapt volgens ISO 7-1.

Buiten en binnendraad kunnen conisch getapt zijn met verhouding 1:16, de binnendraad kan ook parallel getapt zijn. Uitzondering hierop is de binnendraad van de wartels. Hiervoor zijn meerdere draadnormen mogelijk. De toegestane druk is afhankelijk van de bedrijfstemperatuur.

De verdeling is als volgt;

-20° tot 40°C	20 bar
100°C	16.5 bar
150°C	15 bar
200°C	14 bar
220°C	13.5 bar

Het standaard pakket van S.K.S. bestaat uit 2 mogelijkheden. Dit zijn

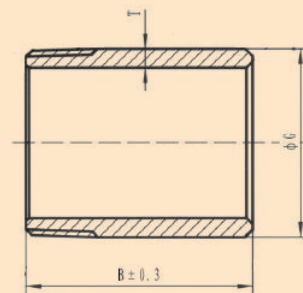

fittingen geproduceerd uit gegoten voormateriaal of van gesmeed voormateriaal. Naast een kwaliteits verschil zijn de gesmede fittingen tevens leverbaar inclusief certificaten.

Materiaal

Standaard worden de onderdelen geleverd in RVS 316 (gegoten) of 316Ti (gesmeed).

Toleranties en specificaties:

ISO 4144 (Threaded fittings), ISO 7-1 (conische draad), ISO 228-1 (cilindrische draad) en ISO 6708 (buisfittingen en maatvoering).

Uitvoeringen

De bochten, T-stuk, verlopen of eindstukken kunnen voorzien zijn van binnendraad, buitendraad, laskant of slangaansluiting. De draad kan zowel conisch of cilindrisch zijn. De koppelingen zijn leverbaar met een conisch afdichtvlak of een vlak dichtvlak met een PTFE dichting.

Certificaten

3.1 certificaat Volgens EN 10204 is alleen mogelijk op de gedraaide uitvoering van gesmeed voormateriaal.

LASNIPPEL SCH40 BUIS (CON. DIN 2999) ISO

Inch	B (316)	B (316Ti)	G	T	E	Kg	316	316Ti
0,125"	30,0	30,0	10,0	2,0		0,01	75736246	75736246D
0,25"	30,0	30,0	14,0	2,2		0,02	75736252	75736252D
0,375"	30,0	35,0	17,2	2,3		0,02	75736258	75736258D
0,5"	35,0	40,0	21,4	2,8		0,04	75736264	75736264D
0,75"	40,0	40,0	26,7	2,9		0,05	75736271	75736271D
1"	40,0	40,0	33,4	3,4		0,08	75736277	75736277D
1,25"	50,0	50,0	42,2	3,6		0,14	75736283	75736283D
1,5"	50,0	50,0	48,3	3,7		0,15	75736289	75736289D
2"	50,0	60,0	60,4	3,9		0,23	75736296	75736296D
2,5"	60,0	50,0	76,0	5,2		0,32	75736299	75736299D
3"	70,0	70,0	88,9	5,5		0,46	75736305	75736305D
4"	80,0	80,0	114,3	5,9		0,84	75736309	75736309D

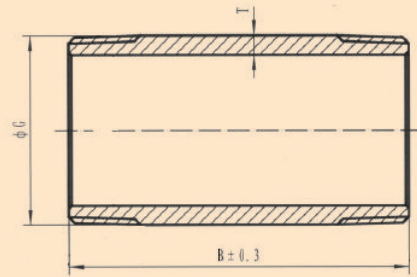

DUBBELE PIJPNIPPEL SCH40 BUIS ISO

Inch	B 316	B 316Ti	G	T	E	Kg	316	316Ti
0,125"	30,0	40,0	10,0	2,00		0,02	75736475	75736475D
0,25"	30,0	40,0	14,0	2,20		0,02	75736481	75736481D
0,375"	30,0	40,0	17,2	2,30		0,03	75736487	75736487D
0,5"	40,0	60,0	21,4	2,77		0,07	75736494	75736494D
0,75"	40,0	60,0	26,7	2,87		0,07	75736500	75736500D
1"	40,0	60,0	33,4	3,38		0,12	75736506	75736506D
1,25"	50,0	80,0	42,2	3,56		0,21	75736513	75736513D
1,5"	60,0	80,0	48,3	3,68		0,24	75736519	75736519D
2"	60,0	100,0	60,4	3,91		0,42	75736525	75736525D
2,5"	60,0	100,0	76,0	5,16		0,53	75736529	75736529D
3"	120,0	120,0	88,9	5,49		0,76	75736535	75736535D
4"	150,0	150,0	114,3	5,87		1,30	75736537	75736537D

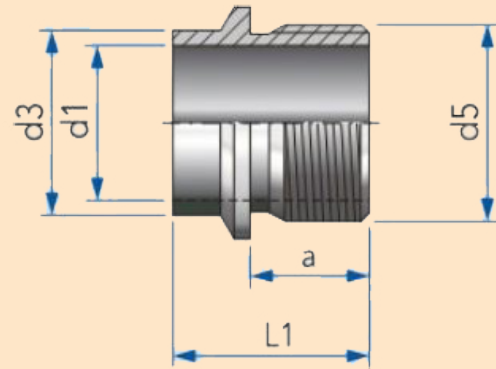
**LASNIPPEL DIN EN10357 BUIS**

DN	d1	d3	d5	a	L1	Kg	316
10	10	13	G 3/8	12	25	0,02	75738201
15	16	19	G 1/2	15	28	0,03	75738202
20	20	23	G 3/4	15	28	0,05	75738203
25	26	29	G1	20	33	0,07	75738205
32	32	35	G1 1/4	20	34	0,12	75738207
40	38	41	G1 1/2	20	35	0,16	75738209
50	50	53	G2	22	37	0,21	75738211
65	66	70	G2 1/2	22	37	0,27	75738213
80	81	85	G3	25	40	0,28	75738215
100	100	104	G4	30	46	0,69	75738217

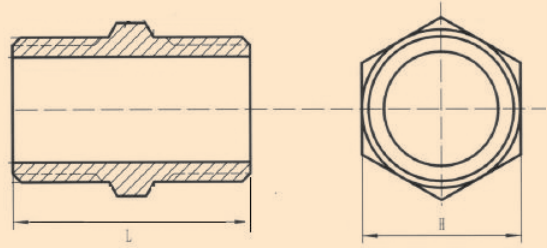
**DUBBELE ZESKANTNIPPEL ISO 4144 N1 ISO**

Inch	L casted	L forged	Hexagon	D	E	Kg	316L casted	316Ti forged
0,125"	20,0	22,0	11,0			0,01	75736230	75736230D
0,25"	25,0	24,0	15,0			0,02	75736231	75736231D
0,375"	27,0	28,0	18,0			0,03	75736232	75736232D
0,5"	34,0	34,0	22,0			0,05	75736233	75736233D
0,75"	36,5	40,0	28,0			0,09	75736234	75736234D
1"	42,0	46,0	35,0			0,13	75736235	75736235D
1,25"	47,5	52,0	43,5			0,21	75736236	75736236D
1,5"	47,5	54,0	49,5			0,26	75736237	75736237D
2"	57,0	62,0	62,0			0,43	75736238	75736238D
2,5"	61,0	70,0	77,5			0,63	75736239	75736239D
3"	67,5	78,0	90,5			0,83	75736240	75736240D

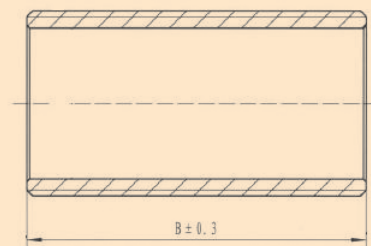
**DRAADNIPPEL (DIN/ISO 228) ISO**

Inch	B casted	B forged	C	D	E	Kg	316 casted	316Ti forged
0,125"	16,0	16,0				0,01	75736215	75736215D
0,25"	18,0	18,0				0,01	75736216	75736216D
0,375"	22,0	22,0				0,02	75736217	75736217D
0,5"	25,0	25,0				0,02	75736218	75736218D
0,75"	30,0	30,0				0,03	75736219	75736219D
1"	35,0	35,0				0,06	75736220	75736220D
1,25"	38,0	38,0				0,07	75736221	75736221D
1,5"	38,0	38,0				0,08	75736222	75736222D
2"	45,0	45,0				0,14	75736223	75736223D
2,5"	55,0	55,0				0,24	75736224	75736224D
3"	60,0	60,0				0,30	75736225	75736225D

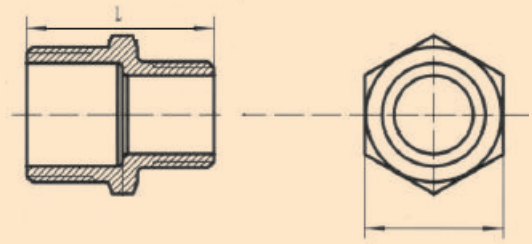
**VERLOOPNIPPEL ISO 4144 N2 ISO**

Inch	L casted	L forged	hexagon	octagon	decagon	Kg	316 casted	316Ti forged
0,25" x 0,125"	22,5	25,0	15,0			0,04	75736313	75736313D
0,375" x 0,125"	24,0	25,5	18,0			0,04	75736314	75736314D
0,375" x 0,25"	26,5	29,0	18,0			0,04	75736315	75736315D
0,5" x 0,125"	27,5	30,0	22,0			0,08	75736316	75736316D
0,5" x 0,25"	30,0	33,0	22,0			0,08	75736317	75736317D
0,5" x 0,375"	30,5	33,5	22,0			0,08	75736318	75736318D
0,75" x 0,125"	29,0	35,0		28,0		0,10	75736319	75736319D
0,75" x 0,25"	31,5	35,0		28,0		0,10	75736320	75736320D
0,75" x 0,375"	32,0	37,0		28,0		0,11	75736321	75736321D
0,75" x 0,5"	35,5	40,5		28,0		0,11	75736322	75736322D
1" x 0,25"	34,5	40,0		35,0		0,18	75736324	75736324D
1" x 0,375"	35,00	40,5		35,0		0,18	75736325	75736325D
1" x 0,5"	38,5	44,0		35,0		0,18	75736326	75736326D
1" x 0,75"	39,5	45,5		35,0		0,15	75736327	75736327D
1,25" x 0,5"	41,5	48,0		43,5		0,27	75736331	75736331D
1,25" x 0,75"	42,5	49,5		43,5		0,27	75736332	75736332D
1,25" x 1"	45	52,0		43,5		0,24	75736333	75736333D
1,5" x 0,5"	41,5	48,0		49,5		0,38	75736337	75736337D
1,5" x 0,75"	42,5	52,0		49,5		0,35	75736338	75736338D
1,5" x 1"	45	52,0		49,5		0,31	75736339	75736339D
1,5" x 1,25"	47,5	54,0		49,5		0,31	75736340	75736340D
2" x 1"	50	59,0		62,0		0,58	75736344	75736344D
2" x 1,25"	52,5	62,0		62,0		0,52	75736345	75736345D
2" x 1,5"	52,5	62,0		62,0		0,53	75736346	75736346D
2,5" x 2"	59	73,0			77,5	0,81	75736352	75736352D
3" x 1,5"	64,5	76,0			90,5	1,20	75736357	75736357D
3" x 2"	62,5	78,0			90,5	1,10	75736358	75736358D
3" x 2,5"	64,5	82,0			90,5	1,10	75736359	75736359D

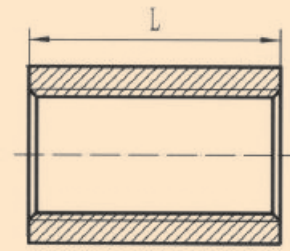
**SOK ISO 4144 S2 ISO**

Inch	L casted	L forged	C	D	E	Kg	316 casted	316Ti forged
0,125"	16,0	17,0				0,02	75736121	75736121D
0,25"	24,0	25,0				0,03	75736122	75736122D
0,375"	25,0	26,0				0,03	75736123	75736123D
0,5"	34,0	34,0				0,07	75736124	75736124D
0,75"	35,5	36,0				0,09	75736125	75736125D
1"	41,0	43,0				0,14	75736126	75736126D
1,25"	47,0	48,0				0,21	75736127	75736127D
1,5"	47,0	48,0				0,29	75736128	75736128D
2"	56,0	56,0				0,40	75736129	75736129D
2,5"	64,0	65,0				0,68	75736130	75736130D
3"	70,0	71,0				0,97	75736131	75736131D
4"	82,0	83,0				1,80	75736132	75736132D

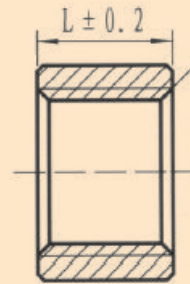
**LASSOK ISO 4144 S1 ISO**

Inch	L casted	L forged	C	D	E	Kg	316 casted	316Ti forged
0,125"	8,5	8,0				0,01	75736200	75736200D
0,25"	12,5	11,0				0,01	75736201	75736201D
0,375"	13,0	12,0				0,02	75736202	75736202D
0,5"	15,0	15,0				0,03	75736203	75736203D
0,75"	17,5	16,0				0,04	75736204	75736204D
1"	21,0	20,0				0,06	75736205	75736205D
1,25"	23,0	22,0				0,09	75736206	75736206D
1,5"	23,0	22,0				0,13	75736207	75736207D
2"	26,0	26,0				0,19	75736208	75736208D
2,5"	30,0	30,0				0,30	75736209	75736209D
3"	32,0	33,0				0,45	75736210	75736210D

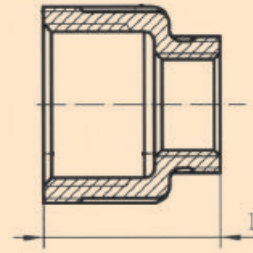
**VERLOOPSOK ISO 4144 S3 ISO**

Inch	L casted	L forged	C	D	E	Kg	316 casted	316 forged
0,25" x 0,125"	25,0	26,0				0,04	75736136	75736136D
0,375" x 0,125"	26,0	-				0,04	75736137	-
0,375" x 0,25"	26,0	30,0				0,04	75736138	75736138D
0,5" x 0,125"	34,0	-				0,08	75736139	-
0,5" x 0,25"	34,0	-				0,08	75736140	-
0,5" x 0,375"	34,0	34,0				0,08	75736141	75736141D
0,75" x 0,125"	36,0	-				0,10	75736142	-
0,75" x 0,25"	36,0	-				0,10	75736143	-
0,75" x 0,375"	36,0	38,0				0,11	75736144	75736144D
0,75" x 0,5"	36,0	40,0				0,11	75736145	75736145D
1" x 0,25"	42,0	-				0,18	75736147	-
1" x 0,375"	42,0	44,0				0,18	75736148	75736148D
1" x 0,5"	42,0	44,0				0,18	75736149	75736149D
1" x 0,75"	42,0	44,0				0,15	75736150	75736150D
1,25" x 0,5"	48,0	50,0				0,27	75736154	75736154D
1,25" x 0,75"	48,0	50,0				0,27	75736155	75736155D
1,25" x 1"	48,0	52,0				0,24	75736156	75736156D
1,5" x 0,5"	52,0	-				0,38	75736160	-
1,5" x 0,75"	52,0	53,0				0,35	75736161	75736161D
1,5" x 1"	52,0	53,0				0,31	75736162	75736162D
1,5" x 1,25"	52,0	53,0				0,31	75736163	75736163D
2" x 1"	58,0	58,0				0,58	75736167	75736167D
2" x 1,25"	58,0	58,0				0,52	75736168	75736168D
2" x 1,5"	58,0	58,0				0,53	75736169	75736169D
2,5" x 2"	65,0	66,0				0,81	75736175	75736175D
3" x 2"	72,0	73,0				1,10	75736181	75736181D
3" x 2,5"	72,0	73,0				1,25	75736182	75736182D

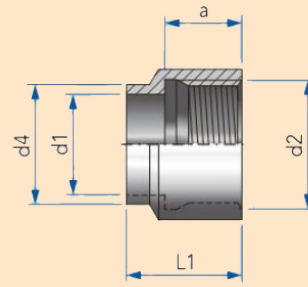
**SOK DIN EN 10357**

DIN	d1	d2	d4	a	L1	Kg	316
10	10	G3/8	13	12	20	0,02	75738101
15	16	G1/2	19	15	25	0,05	75738102
20	20	G3/4	23	15	25	0,05	75738103
25	26	G1	29	20	30	0,08	75738105
32	32	G1 1/4	35	20	30	0,13	75738107
40	38	G1 1/2	41	20	30	0,19	75738109
50	50	G2	53	22	23	0,23	75738111
65	66	G2 1/2	70	22	32	0,30	75738113
80	81	G3	85	25	37	0,51	75738115
100	100	G4	104	30	45	0,86	75738117

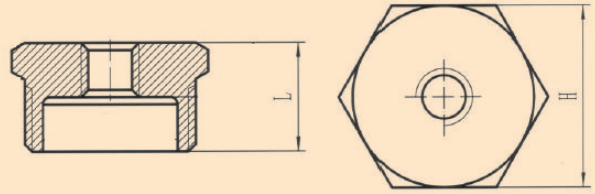
**VERLOOPERING ISO 4144 B1 ISO**

Inch	L forged	L casted	Hexagon	Octagon	D	Kg	316 casted	316Ti casted
0,25" x 0,125"	16,0	17,0	14,0			0,02	75736541	75736541D
0,375" x 0,125"	16,5	17,5	18,0			0,03	75736542	75736542D
0,375" x 0,25"	16,5	17,5	18,0			0,03	75736543	75736543D
0,5" x 0,125"	20,0	21,0	22,0			0,05	75736544	75736544D
0,5" x 0,25"	20,0	21,0	22,0			0,04	75736545	75736545D
0,5" x 0,375"	20,0	21,0	22,0			0,02	75736546	75736546D
0,75" x 0,125"	21,0	24,5	27,5			0,10	75736547	75736547D
0,75" x 0,25"	21,0	24,5	27,5			0,09	75736548	75736548D
0,75" x 0,375"	21,0	24,5	27,5			0,07	75736549	75736549D
0,75" x 0,5"	21,0	24,5	27,5			0,05	75736550	75736550D
1" x 0,25"	24,0	27,0	34,5			0,15	75736552	75736552D
1" x 0,375"	24,0	27,0	34,5			0,15	75736553	75736553D
1" x 0,5"	24,0	27,0	34,5			0,12	75736554	75736554D
1" x 0,75"	24,0	27,0	34,5			0,07	75736555	75736555D
1,25" x 0,5"	27,0	32,5	43,0			0,30	75736559	75736559D
1,25" x 0,75"	27,0	32,5	43,0			0,19	75736560	75736560D
1,25" x 1"	27,0	32,5	43,0			0,12	75736561	75736561D
1,5" x 0,5"	28,5	32,5	49,0			0,35	75736565	75736565D
1,5" x 0,75"	28,5	32,5	49,0			0,36	75736566	75736566D
1,5" x 1"	28,5	32,5	49,0			0,26	75736567	75736567D
1,5" x 1,25"	28,5	32,5	49,0			0,13	75736568	75736568D
2" x 0,5"	32,0	40,0	61,0			0,75	75736570	75736570D
2" x 0,75"	32,0	40,0	61,0			0,74	75736571	75736571D
2" x 1"	32,0	40,0	61,0			0,68	75736572	75736572D
2" x 1,25"	32,0	40,0	61,0			0,52	75736573	75736573D
2" x 1,5"	32,0	40,0	61,0			0,40	75736574	75736574D
2,5" x 2"	37,0	46,0		76,0		0,54	75736580	75736580D
3" x 2"	40,0	51,5		90,0		1,24	75736586	75736586D
3" x 2,5"	40,0	51,5		90,0		0,74	75736587	75736587D

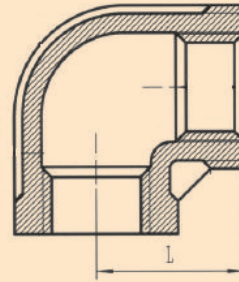

KNIE BINNEN/BINNEN 90° ISO 4144 E1 ISO

Inch	L casted	L forged	C	D	E	Kg	316 casted	316 forged
0,125"	17,0	20,0				0,03	75736650	75736650D
0,25"	19,0	20,0				0,04	75736651	75736651D
0,375"	23,0	22,5				0,06	75736652	75736652D
0,5"	27,5	28,0				0,11	75736653	75736653D
0,75"	32,0	31,0				0,17	75736654	75736654D
1"	38,0	37,0				0,29	75736655	75736655D
1,25"	45,0	44,5				0,46	75736656	75736656D
1,5"	48,0	48,0				0,52	75736657	75736657D
2"	57,0	56,0				0,95	75736658	75736658D
2,5"	69,0	69,0				1,57	75736659	75736659D
3"	78,0	78,0				2,28	75736660	75736660D

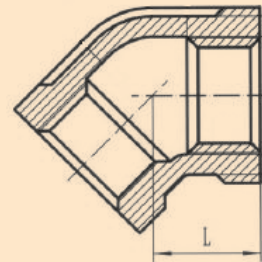

KNIE BINNEN/BINNEN 45° ISO 4144 E3 ISO

Inch	L casted	L forged	C	D	E	Kg	316 casted	316 forged
0,125"	16,0	-				0,03	75736665	75736665D
0,25"	17,0	19,0				0,04	75736666	75736666D
0,375"	19,0	21,0				0,06	75736667	75736667D
0,5"	21,0	22,0				0,11	75736668	75736668D
0,75"	25,0	25,0				0,17	75736669	75736669D
1"	29,0	29,0				0,29	75736670	75736670D
1,25"	33,0	33,0				0,46	75736671	75736671D
1,5"	37,0	36,0				0,52	75736672	75736672D
2"	42,0	43,0				0,95	75736673	75736673D
2,5"	49,0	-				1,57	75736674	75736674D
3"	54,0	-				2,28	75736675	75736675D
4"	64,0	-				3,68	75736676	75736676D

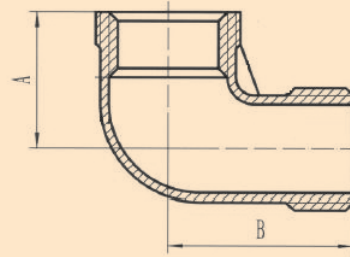

KNIE BINNEN/BUITEN 90° ISO 4144 E4 ISO

Inch	A casted	B casted	A forged	B forged	E	Kg	316 casted	316 forged
0,125"	17,0	26,0	20,0	26,0		0,03	75736680	75736680D
0,25"	19,0	28,0	20,0	30,0		0,04	75736681	75736681D
0,375"	23,0	30,0	24,0	36,0		0,06	75736682	75736682D
0,5"	27,0	36,0	28,0	41,0		0,11	75736683	75736683D
0,75"	32,0	40,0	34,0	48,0		0,17	75736684	75736684D
1"	38,0	47,0	39,0	54,0		0,29	75736685	75736685D
1,25"	45,0	55,0	46,0	62,0		0,46	75736686	75736686D
1,5"	48,0	57,0	48,0	68,0		0,52	75736687	75736687D
2"	57,0	70,0	57,0	83,0		0,95	75736688	75736688D
2,5"	69,0	83,0				1,57	75736689	-
3"	78,0	94,0				2,28	75736690	-

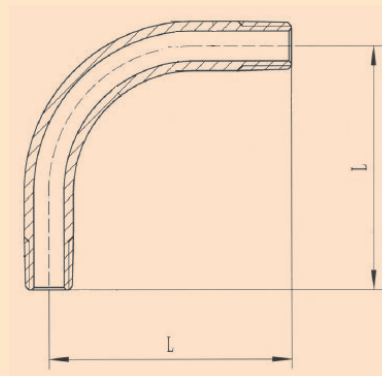

DRAADBOCHT 90° BUITEN/BUITEN ISO

Inch	L 316	L 316Ti	C	D	E	Kg	316	316Ti
0,125"	50,0	50,0				0,05	75736740	75736740D
0,25"	60,0	60,0				0,10	75736741	75736741D
0,375"	70,0	70,0				0,15	75736742	75736742D
0,5"	80,0	80,0				0,23	75736743	75736743D
0,75"	100,0	100,0				0,35	75736744	75736744D
1"	120,0	120,0				0,61	75736745	75736745D
1,25"	140,0	140,0				0,93	75736746	75736746D
1,5"	160,0	160,0				1,18	75736747	75736747D
2"	190,0	190,0				1,95	75736748	75736748D
2,5"	-	240,0					-	75736749D
3"	-	290,0					-	75736750D
4"	-	375,0					-	75736751D

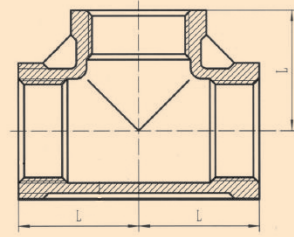
**T-STUK 3XBINNENDRAAD ISO 4144 T1 ISO**

Inch	L casted	L forged	C	D	E	Kg	316 casted	316Ti forged
0,125"	17,0	16,0				0,04	75736635	75736635D
0,25"	19,0	21,0				0,05	75736636	75736636D
0,375"	23,0	25,0				0,08	75736637	75736637D
0,5"	27,5	28,0				0,15	75736638	75736638D
0,75"	32,0	33,0				0,26	75736639	75736639D
1"	38,0	38,0				0,37	75736640	75736640D
1,25"	45,0	45,0				0,61	75736641	75736641D
1,5"	48,0	50,0				0,91	75736642	75736642D
2"	57,0	58,0				1,18	75736643	75736643D
2,5"	69,0	75,0				1,88	75736644	75736644D
3"	78,0	85,0				3,37	75736645	75736645D

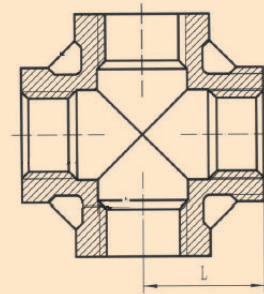
**KRUISSTUK 4X BINNENDRAAD ISO 4144 X1 ISO**

Inch	L casted	L forged	C	D	E	Kg	316 casted	316 forged
0,125"	17,0	16,0				0,04	75736695	75736695D
0,25"	19,0	19,8				0,05	75736696	75736696D
0,375"	23,0	24,0				0,08	75736697	75736697D
0,5"	27,5	28,0				0,15	75736698	75736698D
0,75"	32,0	33,0				0,26	75736699	75736699D
1"	38,0	37,5				0,37	75736700	75736700D
1,25"	45,0	45,5				0,61	75736701	75736701D
1,5"	48,0	49,5				0,91	75736702	75736702D
2"	57,0	57,5				1,18	75736703	75736703D
2,5"	69,0	67,0				1,88	75736704	75736704D
3"	78,0	78,0				3,37	75736705	75736705D
4"	96,0	96,0				4,88	75736706	75736706D

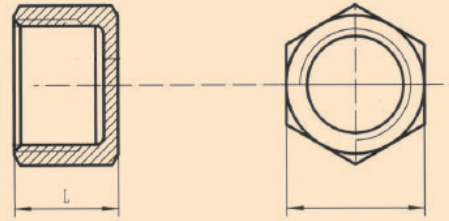

ZESKANT KAP ISO 4144 C1 ISO

Inch	L casted	L forged	C	D	E	Kg	316 casted	316Ti forged
0,125"	13,5	13,0				0,01	75736785	75736785D
0,25"	17,0	17,0				0,01	75736786	75736786D
0,375"	17,5	18,0				0,03	75736787	75736787D
0,5"	21,0	22,0				0,06	75736788	75736788D
0,75"	22,5	24,0				0,08	75736789	75736789D
1"	26,0	28,0				0,11	75736790	75736790D
1,25"	29,0	30,0				0,24	75736791	75736791D
1,5"	29,0	31,0				0,25	75736792	75736792D
2"	33,5	35,0				0,52	75736793	75736793D
2,5"	38,5	40,0				0,74	75736794	75736794D
3"	42,0	45,0				0,86	75736795	75736795D

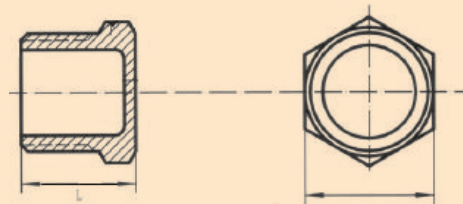

PLUG ISO 4144 P2 ISO

Inch	L casted	L forged	hexagon	octagon	decagon	Kg	316 casted	316Ti forged
0,125"	12,0	13,0	11			0,01	75736830	75736830D
0,25"	14,5	17,0	15			0,02	75736831	75736831D
0,375"	16,0	17,0	18			0,03	75736832	75736832D
0,5"	19,5	21,0	22			0,05	75736833	75736833D
0,75"	21,0	24,0		28		0,11	75736834	75736834D
1"	24,0	27,0		35		0,19	75736835	75736835D
1,25"	27,0	32,0		43,5		0,36	75736836	75736836D
1,5"	27,0	33,0		49,5		0,48	75736837	75736837D
2"	32,0	38,0		62		0,90	75736838	75736838D
2,5"	34,0	45,0				1,64	75736839	75736839D
3"	37,5	48,0				2,32	75736840	75736840D

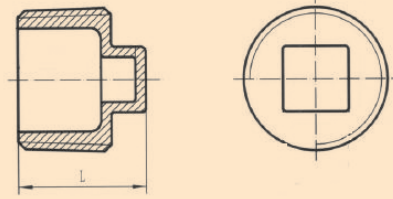

VIERKANT PLUG ISO 4144 P1 ISO

Inch	L casted	L forged	C	D	E	Kg	316 casted	316Ti forged
0,125"	13,0	15,0				0,01	75736875	75736875D
0,25"	15,5	18,0				0,02	75736876	75736876D
0,375"	16,0	20,0				0,03	75736877	75736877D
0,5"	20,5	28,0				0,04	75736878	75736878D
0,75"	21,5	30,0				0,09	75736879	75736879D
1"	25,0	32,0				0,16	75736880	75736880D
1,25"	27,5	35,0				0,29	75736881	75736881D
1,5"	28,5	37,0				0,39	75736882	75736882D
2"	33,0	42,0				0,69	75736883	75736883D
2,5"	37,0	46,0				1,17	75736884	75736884D
3"	42,0	50,0				1,74	75736885	75736885D
4"	48,0	60,0				2,35	75736886	75736886D

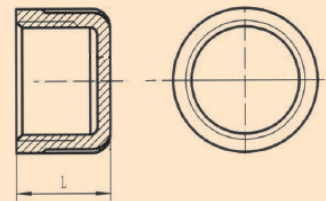

RONDE DOP ISO 4144 P1 ISO

Inch	A	B	C	D	E	Kg	316
0,125"	13,5					0,02	75736805
0,25"	17,0					0,03	75736806
0,375"	17,5					0,03	75736807
0,5"	21,0					0,05	75736808
0,75"	22,5					0,09	75736809
1"	26,0					0,14	75736810
1,25"	29,0					0,22	75736811
1,5"	29,0					0,28	75736812
2"	33,5					0,48	75736813
2,5"	38,5					0,75	75736814
3"	42,0					1,13	75736815

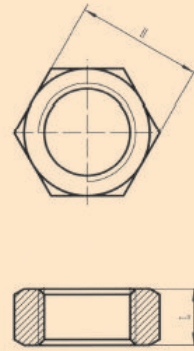
**ZESKANTMOER ISO**

Inch	L	Hexagon	Octagon	Decagon	E	Kg	316
0,125"	5,0	15,0				0,01	75736620
0,25"	7,0	18,0				0,02	75736621
0,375"	8,0	22,0				0,03	75736622
0,5"	10,0	27,0				0,04	75736623
0,75"	11,0		32,0			0,05	75736624
1"	10,0		40,0			0,08	75736625
1,25"	11,0		48,0			0,13	75736626
1,5"	12,0		55,0			0,13	75736627
2"	13,0		68,0			0,22	75736628
2,5"	16,0			85,0		0,40	75736629
3"	19,0			100,0		0,48	75736630
4"	20,0			125,0		0,55	75736631

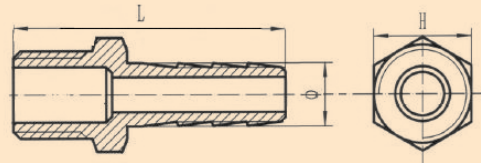

SLANGPILAAK ISO

Inch	L forged	Ø forged	L casted	Ø casted	hexagon	Kg	316 casted	316Ti forged
0,125"	38,0	6,0	33,0	6,0	11,0	0,02	75736920	75736920D
0,25"	42,5	9,0	46,5	9,0	17,0	0,02	75736921	75736921D
0,375"	49,0	11,0	57,5	11,0	19,5	0,04	75736922	75736922D
0,5"	57,5	13,0	65,5	13,0	22,0	0,06	75736923	75736923D
0,75"	66,0	20,0	71,0	20,0	30,5	0,10	75736924	75736924D
1"	76,0	25,0	75,0	25,0	36,5	0,16	75736925	75736925D
1,25"	79,0	33,0	81,0	33,0	46,5	0,35	75736926	75736926D
1,5"	83,0	40,0	95,5	40,0	50,5	0,43	75736927	75736927D
2"	92,0	51,5	100,5	51,5	60,5	0,78	75736928	75736928D
2,5"	99,0	67,0	102,0	67,0	81,0	1,58	75736929	-

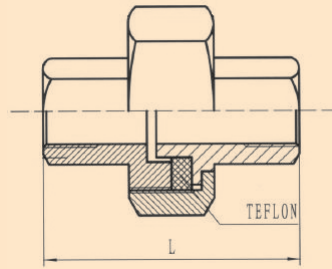
KOPPELING BINNEN/BINNENDRAAD VLAK DICTEND ISO 4144 U1 ISO

Inch	L casted	L forged	C	D	E	Kg	316 casted	316Ti forged
0,125"	30,0	32,0				0,08	75736061	75736061D
0,25"	33,5	38,0				0,07	75736062	75736062D
0,375"	36,5	41,0				0,09	75736063	75736063D
0,5"	39,5	46,0				0,13	75736064	75736064D
0,75"	42,5	50,0				0,21	75736065	75736065D
1"	50,0	56,0				0,30	75736066	75736066D
1,25"	54,0	62,0				0,43	75736067	75736067D
1,5"	58,0	64,0				0,58	75736068	75736068D
2"	65,0	69,0				1,08	75736069	75736069D
2,5"	75,0	75,0				3,40	75736070	75736070D
3"	83,0	83,0				2,45	75736071	75736071D
4"	-	95,0				3,30	-	75736072D

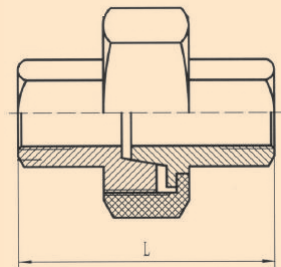

KOPPELING BINNEN/BINNENDRAAD CONISCH DICTEND ISO 4144 U4 ISO

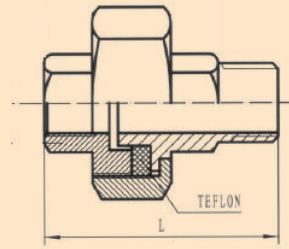
Inch	L casted	L forged	C	D	E	Kg	316 casted	316Ti forged
0,125"	30,0	32,0				0,06	75736001	75736001D
0,25"	33,5	38,0				0,11	75736002	75736002D
0,375"	36,5	41,0				0,18	75736003	75736003D
0,5"	39,5	46,0				0,24	75736004	75736004D
0,75"	42,5	50,0				0,35	75736005	75736005D
1"	50,0	56,0				0,56	75736006	75736006D
1,25"	54,0	62,0				0,69	75736007	75736007D
1,5"	58,0	64,0				0,86	75736008	75736008D
2"	65,0	69,0				1,21	75736009	75736009D
2,5"	75,0	75,0				1,84	75736010	75736010D
3"	83,0	83,0				2,62	75736011	75736011D
4"	-	95,0				3,30	-	75736012D

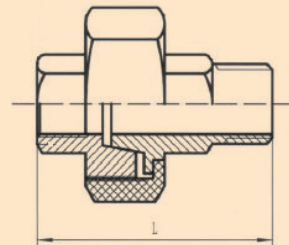

KOPPELING BINNEN/BUITENDRAAD VLAK DICTEND ISO 4144 U2 ISO

Inch	L casted	L forged	C	D	E	Kg	316 casted	316Ti forged
0,125"	38,0	38,5				0,09	75736076	75736076D
0,25"	44,0	47,5				0,09	75736077	75736077D
0,375"	47,5	51,5				0,11	75736078	75736078D
0,5"	54,0	58,5				0,17	75736079	75736079D
0,75"	58,0	65,0				0,26	75736080	75736080D
1"	68,0	73,0				0,39	75736081	75736081D
1,25"	74,5	83,0				0,59	75736082	75736082D
1,5"	78,5	88,0				0,73	75736083	75736083D
2"	90,0	94,5				1,30	75736084	75736084D
2,5"	102,0	104,0				3,57	75736085	75736085D
3"	113,0	115,0				2,91	75736086	75736086D
4"	-	135,0				3,45	-	75736087D



KOPPELING BINNEN/BUITENDRAAD CONISCH DICTEND ISO 4144 U5 ISO

Inch	L casted	L forged	C	D	E	Kg	316 casted	316Ti forged
0,215"	38,0	38,5				0,07	75736016	75736016D
0,25"	44,0	47,5				0,12	75736017	75736017D
0,375"	47,5	51,5				0,20	75736018	75736018D
0,5"	54,0	58,5				0,29	75736019	75736019D
0,75"	58,0	65				0,42	75736020	75736020D
1"	68,0	73				0,67	75736021	75736021D
1,25"	74,5	83				0,90	75736022	75736022D
1,5"	78,5	88				1,09	75736023	75736023D
2"	90,0	94,5				1,53	75736024	75736024D
2,5"	102,0	104				2,32	75736025	75736025D
3"	113,0	115				3,42	75736026	75736026D
4"	-	135				4,12	-	75736027D

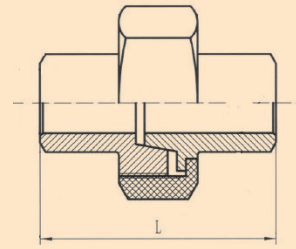

KOPPELING LAS/LAS CONISCH DICTEND ISO

Inch	L casted	L forged	C	D	E	Kg	316 casted	316Ti forged
0,125"	26,0	35,0				0,06	75736046	75736046D
0,25"	35,5	35,0				0,08	75736047	75736047D
0,375"	38,0	40,0				0,09	75736048	75736048D
0,5"	44,0	48,0				0,13	75736049	75736049D
0,75"	45,0	55,0				0,21	75736050	75736050D
1"	50,0	62,0				0,30	75736051	75736051D
1,25"	55,0	66,0				0,43	75736052	75736052D
1,5"	57,0	73,0				0,58	75736053	75736053D
2"	65,0	75,0				1,08	75736054	75736054D
2,5"	71,0	90,0				3,40	75736055	75736055D
3"	80,0	100,0				2,45	75736056	75736056D
4"	-	105,0				3,30	-	75736057D

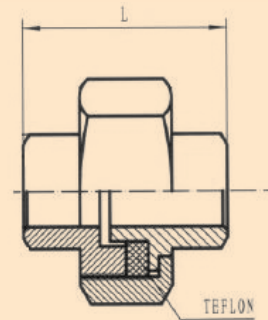

KOPPELING LAS/LAS VLAK DICTEND ISO

Inch	L casted	L forged	C	D	E	Kg	316 casted	316Ti forged
0,125"	26,0	35				0,06	75736091	75736091D
0,25"	35,5	35				0,08	75736092	75736092D
0,375"	38,0	40				0,09	75736093	75736093D
0,5"	44,0	48				0,13	75736094	75736094D
0,75"	45,0	55				0,21	75736095	75736095D
1"	50,0	62				0,30	75736096	75736096D
1,25"	55,0	66				0,43	75736097	75736097D
1,5"	57,0	73				0,58	75736098	75736098D
2"	65,0	75				1,08	75736099	75736099D
2,5"	71,0	90				3,40	75736100	75736100D
3"	80,0	100				2,45	75736101	75736101D
4"	-	105				3,20	-	75736102D

Knelfittingen

S.K.S. heeft in haar pakket een brede range snijring fittingen opgenomen die voldoen aan de norm EN ISO 8434-1 (DIN 2353). De snijring aansluitingen worden volgens de Bohringsform W DIN 3861. Naast de in deze catalogus opgenomen uitvoeringen, biedt S.K.S. een groot aantal extra varianten. De snijringkoppelingen zijn in 3 bouwgroepen verdeeld:

- LL: Dit type is bedoeld voor toepassingen met bijvoorbeeld perslucht, kunststof leidingen, laboratoria, etc.; voor toepassingen met lagere druk tot max. PN100.
- L: Voor hogere drukbelasting tot max. PN 315, zoals gebruikt wordt in de meet- en regeltechniek, papier- en kunststofindustrie en hydraulische installaties
- S: Type S wordt toegepast in applicaties met drukstoten en hoge mechanische belasting in bijvoorbeeld scheepsbouw, chemische en offshore industrie. Drukbereik van PN250 tot PN400 en bij gebruik van conische inschroefdraad tot PN630.

Type	Buis diameter	Nenn druck
LL	4 – 8 mm	100 bar
L	6 – 18 mm	315 bar
L	22 – 42 mm	160 bar
S	6 -14 mm	630 bar
S	16 - 30 mm	400 bar
S	38 mm	315 bar
S	50 mm	250 bar

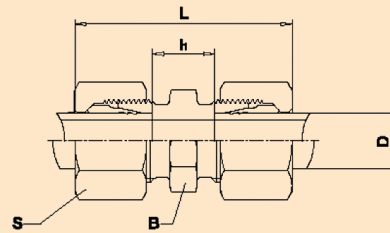

SNIJRINGKOPPELING RECHT KNELXKNEL DIN 2353 METRISCH

MM	Type	A	PN	C	D	Kg	316Ti forged
4	LL	31	100			0,04	77121006
6	L	39	315			0,04	77121008
8	L	40	315			0,07	77121010
10	L	42	315			0,07	77121012
12	L	43	315			0,09	77121014
15	L	46	315			0,15	77121016
18	L	48	315			0,21	77121018
22	L	52	160			0,28	77121020
28	L	54	160			0,30	77121022
14	S	57	630			0,15	77121036
16	S	57	400			0,14	77121038
20	S	66	400			0,28	77121040
25	S	74	400			0,30	77121042
30	S	80	400			0,35	77121044
38	S	90	315			0,42	77121046

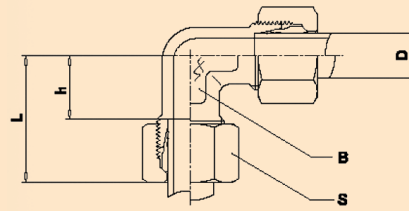

SNIJRINGKOPPELING HAAKS KNELXKNEL DIN 2353 METRISCH

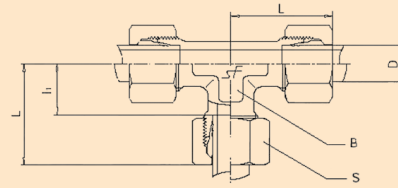
MM	Type	A	PN	C	D	Kg	316Ti forged
4	LL	21	100			0,04	77121056
6	L	27	315			0,05	77121058
8	L	29	315			0,06	77121060
10	L	30	315			0,09	77121062
12	L	32	315			0,11	77121064
15	L	36	315			0,21	77121066
18	L	40	315			0,33	77121068
22	L	44	160			0,44	77121070
28	L	47	160			0,58	77121072
14	S	40	630			0,21	77121086
16	S	43	400			0,20	77121088
20	S	48	400			0,44	77121090
25	S	54	400			0,55	77121092
30	S	62	400			0,68	77121094
38	S	72	315			0,89	77121096

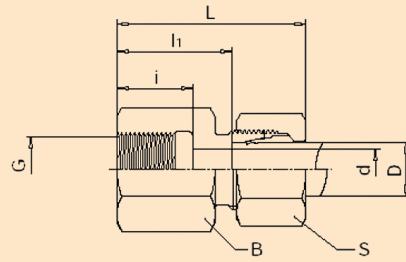

SNIJRINGKOPPELING T-STUK DIN 2353 METRISCH

MM	Type	A	PN	C	D	Kg	316Ti forged
4	LL	21	100			0,06	77121106
6	L	27	315			0,06	77121108
8	L	29	315			0,09	77121110
10	L	30	315			0,12	77121112
12	L	32	315			0,13	77121114
15	L	36	315			0,27	77121116
18	L	40	315			0,39	77121118
22	L	44	160			0,51	77121120
28	L	47	160			0,53	77121122
14	S	40	630			0,22	77121136
16	S	43	400			0,26	77121138
20	S	48	400			0,53	77121140
25	S	54	400			0,47	77121142
30	S	62	400			0,72	77121144
38	S	72	315			0,89	77121146

RECHTE OPSCHROEF KNEL KOPPELING DIN 2353 METRISCH

Maat	Type	A	PN	C	D	Kg	316Ti forged
6mm x 0,125"	L	34	315			0,06	77321402
6mm x 0,25"	L	39	315			0,06	77321404
8mm x 0,25"	L	39	315			0,09	77321406
10mm x 0,25"	L	40	315			0,12	77321408
15mm x 0,375"	L	42	315			0,15	77321414
15mm x 0,5"	L	46	315			0,15	77321416
18mm x 0,375"	L	44	315			0,28	77321418
28mm x 1"	L	55	160			0,43	77321424
14mm x 0,5"	S	50	630			0,18	77321444
20mm x 0,75"	S	56	400			0,28	77321452
25mm x 1"	S	62	400			0,42	77321454

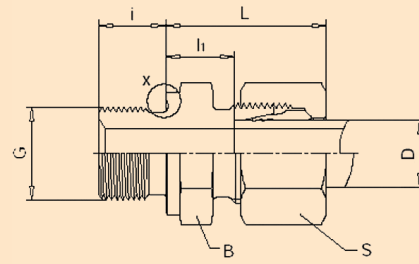

RECHTE INSCHROEF KNELKOPPELING DIN 2353 METRISCH

Maat	Type	A	PN	C	D	Kg	316Ti forged
4mm x 0,125"	LL	33,5	100			0,05	77436002
6mm x 0,125"	L	30,5	315			0,06	77321001
6mm x 0,25"	L	34,5	315			0,06	77321002
6mm x 0,375"	L	38	315			0,06	77321003
6mm x 0,5"	L	40,5	315			0,07	77321004
8mm x 0,125"	LL	28	100			0,09	77321005
8mm x 0,25"	L	35	315			0,09	77321006
8mm x 0,375"	L	38	315			0,09	77321007
8mm x 0,5"	L	40,5	315			0,10	77321008
10mm x 0,125"	L	33,5	315			0,12	77321009
10mm x 0,25"	L	38	315			0,12	77321010
10mm x 0,375"	L	39,5	315			0,12	77321011
10mm x 0,5"	L	43	315			0,13	77321012
12mm x 0,25"	L	38	315			0,14	77321014
12mm x 0,375"	L	39,5	315			0,14	77321015
12mm x 0,5"	L	42	315			14,00	77321016
15mm x 0,375"	L	43	315			0,15	77321017
15mm x 0,5"	L	45	315			0,15	77321018
15mm x 0,75"	L	46	315			0,16	77321019
18mm x 0,375"	L	43	315			0,26	77321020
18mm x 0,5"	L	47	315			0,28	77321021
18mm x 0,75"	L	47	315			0,32	77321022
22mm x 0,5"	L	47	160			0,44	77321023
22mm x 0,75"	L	49	160			0,44	77321024
22mm x 1"	L	52	160			0,50	77321025
28mm x 0,75"	L	49	160			0,62	77321027
28mm x 1"	L	52	160			0,64	77321028
14mm x 0,375"	S	49	630			0,18	77321053
14mm x 0,5"	S	51	630			0,28	77321054
14mm x 0,75"	S	55	630			0,30	77321055
16mm x 0,375"	S	47	400			0,42	77321057
16mm x 0,5"	S	51	400			0,42	77321058
20mm x 0,5"	S	56	400			0,52	77321060
20mm x 0,75"	S	58	400			0,53	77321061
20mm x 1"	S	62	400			0,58	77321062

Maat	Type	A	PN	C	D	Kg	316Ti forged
25mm x 0,75"	S	61	400			0,85	77321065
25mm x 1"	S	65	400			0,92	77321066
30mm x 1"	S	68	400			1,10	77321069
30mm x 1,25"	S	70	400			1,10	77321070
30mm x 1,5"	S	75	400			1,50	77321071
38mm x 1,25"	S	74	315			2,10	77321072
38mm x 1,5"	S	79	315			2,10	77321073

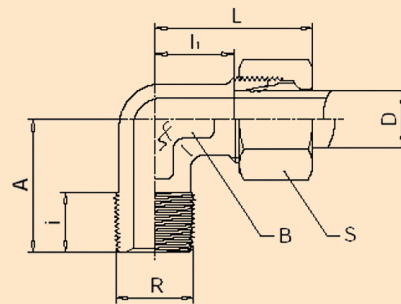

HAAKSE INSCHROEF KNELKOPPELING DIN 2353 METRISCH

Maat	Type	A	PN	C	D	Kg	316Ti forged
6mm x 0,125"	L	30,5	315			0,06	77421108
6mm x 0,25"	L	34,5	315			0,06	77421110
8mm x 0,125"	LL	28	100			0,09	77421112
8mm x 0,25"	L	35	315			0,09	77421114
8mm x 0,375"	L	38	315			0,09	77421116
8mm x 0,5"	L	40,5	315			0,10	77421118
10mm x 0,25"	L	38	315			0,12	77421120
10mm x 0,375"	L	39,5	315			0,12	77421122
10mm x 0,5"	L	43	315			0,13	77421124
12mm x 0,25"	L	38	315			0,14	77421126
12mm x 0,375"	L	39,5	315			0,14	77421128
12mm x 0,5"	L	42	315			14,00	77421130
15mm x 0,375"	L	43	315			0,15	77421131
15mm x 0,5"	L	45	315			0,15	77421132
18mm x 0,5"	L	47	315			0,28	77421134
14mm x 0,375"	S	49	630			0,18	77421158
14mm x 0,5"	S	51	630			0,28	77421160
16mm x 0,5"	S	51	400			0,42	77421162

RVS Kogelkranen

Ter completering van het BSP / gasdraad programma heeft S.K.S. een brede range kogelkranen. In onderstaande overzichten geven we weer wat uit voorraad leverbaar is. Daarnaast heeft S.K.S. mogelijkheden voor diverse andere modellen. Dit kan variëren in kranen voor hogere drukken, speciale aansluitingen of ander soort bedieningen, zoals pneumatisch of elektrisch. De draadaansluitingen hebben conische draad volgens ISO 7-1 en DIN 2999-1 (BSP). De standaard kogelkranen zijn "blow out proof" en bestand tegen ca. 69 bar (1000 PSI) bij 40°C. Voor hogere drukken of toepassingen waar andere eisen gesteld worden, verwijzen wij u naar de catalogus industriële afsluiters. U kunt natuurlijk ook contact met onze verkopers opnemen. De standaard kogelkranen zijn inzetbaar in applicaties met: Max. werkdruk 63 bar / 1000 PSI
Temperatuur range van -20° tot 132°C

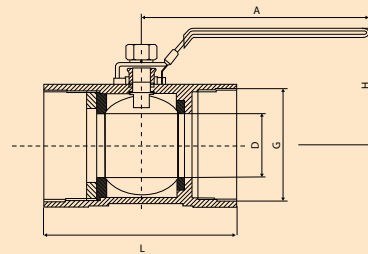

KOGELKRAAN 1-DELIG BINNEN/BINNENDRAAD WP= 63 BAR ISO

Inch + (G)	D	L	H	A		Kg	316
0,25"	5,0	41,0	29,0	70,0		0,07	80136132
0,375"	7,0	46,0	30,0	70,0		0,10	80136134
0,5"	9,0	56,0	35,0	100,0		0,15	80136136
0,75"	12,5	60,0	37,0	100,0		0,26	80136138
1"	15,0	72,0	44,0	110,0		0,40	80136140
1,25"	20,0	78,0	49,0	110,0		0,65	80136142
1,5"	23,0	85,0	51,0	140,0		0,87	80136144
2"	32,0	100,0	64,0	140,0		1,46	80136146

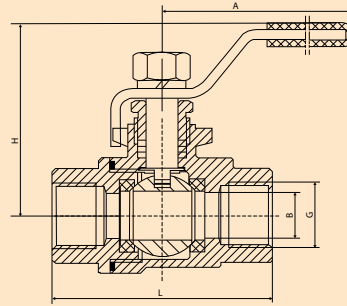

KOGELKRAAN 2-DELIG BINNEN/BINNENDRAAD WP= 63 BAR ISO

Inch + (G)	D	L	H	A	Kg	316
0,25"	8,0	50,0	45,0	100,0	0,09	80136002
0,375"	12,0	60,0	53,0	100,0	0,13	80136004
0,5"	15,0	75,0	58,0	110,0	0,20	80136006
0,75"	20,0	80,0	64,0	120,0	0,33	80136008
1"	25,0	90,0	71,0	145,0	0,48	80136010
1,25"	32,0	110,0	76,0	145,0	0,72	80136012
1,5"	40,0	120,0	87,0	160,0	1,05	80136014
2"	50,0	140,0	97,0	170,0	1,62	80136016
2,5"	65,0	185,0	128,0	230,0	2,43	80136018
3"	80,0	205,0	137,0	260,0	3,23	80136020

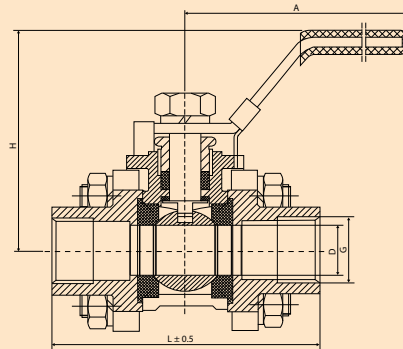

KOGELKRAAN 3-DELIG 2X BINNENDRAAD ISO TOP, WP= 63 BAR ISO

Inch + (G)	D	L	H	A	Kg	316
0,25"	8,0	60,0	55,0	100,0	0,09	80136602
0,375"	10,0	60,0	55,0	100,0	0,13	80136603
0,5"	15,0	75,0	56,0	100,0	0,20	80136604
0,75"	20,0	80,0	62,0	125,0	0,33	80136605
1"	25,0	90,0	66,0	125,0	0,48	80136606
1,25"	32,0	110,0	77,0	130,0	0,72	80136607
1,5"	38,0	120,0	81,0	166,0	1,05	80136608
2"	50,0	140,0	107,0	190,0	1,62	80136609
2,5"	65,0	185,0	128,0	215,0	2,43	80136610
3"	80,0	205,0	117,0	253,0	3,23	80136611
4"	100,0	240,0	158,0	285,0	6,40	80136612

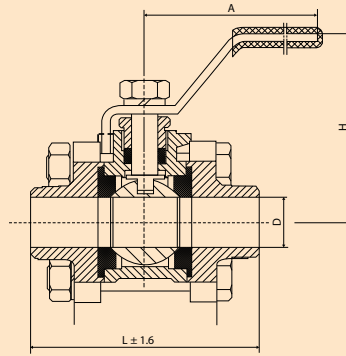

KOGELKRAAN 3-DELIG 2X LAS ISO TOP, WP= 63 BAR ISO

Inch	D	L	H	A		Kg	316 manual
0,25"	8,0	60	55,0	100,0		0,09	80136252
0,375"	10,0	60	55,0	100,0		0,13	80136254
0,5"	15,0	68	58,0	110,0		0,20	80136256
0,75"	20,0	78	64,0	120,0		0,33	80136258
1"	25,0	86	69,0	145,0		0,48	80136260
1,25"	32,0	110	79,0	145,0		0,72	80136262
1,5"	38,0	117	84,0	160,0		1,05	80136264
2"	50,0	140	110,0	170,0		1,62	80136266
2,5"	65,0	164	122,0	230,0		2,43	80136268
3"	80,0	213	145,0	260,0		3,23	80136270
4"	100,0	240	155,0	300,0		6,40	80136272

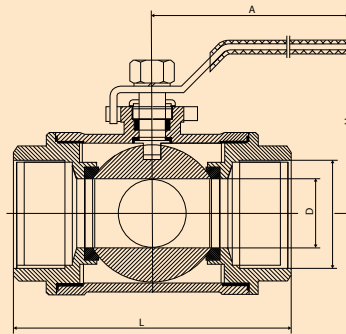

3-WEG KOGELKRAAN 3X BINNENDRAAD, L-BORING WP= 63 BAR ISO

Inch	D	L	H	A		Kg	316 manual
0,25"	8,0	60	55,0	100,0		0,09	80136402
0,375"	10,0	60	55,0	100,0		0,13	80136404
0,5"	12,0	73	57,0	110,0		0,20	80136406
0,75"	15,0	80	61,0	120,0		0,33	80136408
1"	18,0	88	67,0	145,0		0,48	80136410
1,25"	25,0	125	81,0	145,0		0,72	80136412
1,5"	32,0	136	97,0	160,0		1,05	80136414
2"	38,0	158	108,0	170,0		1,62	80136416
2,5"	50,0	200	130,0	230,0		2,43	80136418
3"	65,0	240	140,0	260,0		3,23	80136420

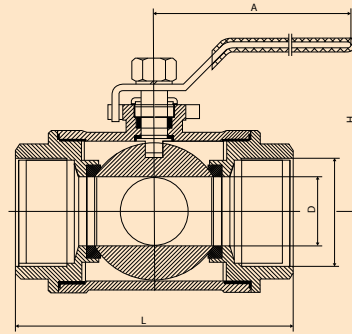

3-WEG KOGELKRAAN 3X BINNENDRAAD, T-BORING WP= 63 BAR ISO

Inch	D	L	H	A		Kg	316 manual
0,25"	8,0	60	55,0	100,0		0,09	80136452
0,375"	10,0	60	55,0	100,0		0,13	80136454
0,5"	12,0	73	57,0	110,0		0,20	80136456
0,75"	15,0	80	61,0	120,0		0,33	80136458
1"	18,0	88	67,0	145,0		0,48	80136460
1,25"	25,0	125	81,0	145,0		0,72	80136462
1,5"	32,0	136	97,0	160,0		1,05	80136464
2"	38,0	158	108,0	170,0		1,62	80136466
2,5"	50,0	200	130,0	230,0		2,43	80136468
3"	65,0	240	140,0	260,0		3,23	80136470



Verbruiksmaterialen

Om "One stop shopping" nog meer invulling te geven, heeft S.K.S. ook een uitgekiend pakket verbruiksmaterialen. Dit pakket is gebaseerd op de levering historie bij verschillende klanten van S.K.S.

Met deze keuze aan materialen, biedt S.K.S. u een mogelijkheid om d.m.v. combinatie inkopen een besparing te realiseren op de verkrijgingkosten. Van uw technische inkopen. In haar marktgerichte concepten omschrijft S.K.S. haar meerwaarde als logistieke partner. Dit is vooral gebaseerd op het reduceren van uw aantal toeleveranciers binnen het pakket technische materialen.

Naast het brede standaard pakket, zijn verbruiksmaterialen een van de vele mogelijkheden om ons pakket aan uw wensen aan te passen

Bevestigingsmaterialen

Voor het monteren en assembleren van de diverse leidingcomponenten, kan men niet zonder de noodzakelijke bevestigingsmaterialen. Ter completering van uw opdrachten heeft S.K.S. de meest voorkomende onderdelen in haar pakket opgenomen. De mogelijkheden zijn onderverdeeld in de volgende groepen.

- Inslagdoppen
- Bouten en moeren
- Slangklemmen
- Scharnieren

Omschrijving	art.nr. SKS
Scotch brite 100 mm (per rol a 10 mtr)	90900785
RVS glans (reinigingsmiddel)	98100787
Beitspasta transparant per pot a 2 kg.	98100788
Beitspasta wit per pot a 2 kg.	98100789
Zuurbestendige kwasten	98300920
PTFE (Teflon) tape met Gastec keur (0,1mm L= 12 mtr.) kl.0,2	90900790
Schroefdraadafdichting Loctite 542	90900791
Lamellenschijf con. 115x22 K60 zirk.	90900840
Afbraamschijf 115x7x22,2 RVS TR5296	98300901
Afbraamschijf 178x7x22,2 RVS TR5362	98300902
Snijschijf 115x2x22,2 RVS TR2073	98300904
Snijschijf 178x2x22,2 RVS TR3131	98300905
Molybdeentester (flacon)	98300910

Flensverbinding (EN 1092-1)

Voor industriële leidingen is de meest toegepaste verbinding, die met behulp van flenzen. Veel appendages zijn uitgevoerd met een flensverbinding en kunnen op die manier spanningsvrij uit de leiding genomen worden. De norm EN 1092-1 is de actuele norm voor flenzen en vervangt daarmee alle Din en ISO normen. Wat voorheen in alle verschillende normen werd gespecificeerd, wordt nu in 1 norm met verschillende type nummers omschreven. De norm EN 1092-1 heeft een directe link met EN 10217-7 voor de buizen en EN 10253-4 voor lasfittingen en dus ook een directe link met de PED. (Pressure Equipment Directive 97/23/EC)

Maatreeks en materiaal EN 1092-1

Aansluiting op maatreeks volgens ISO 4200

Materiaal volgens EN 10088-1

Toleranties en specificaties:

DIN ISO 2768-1 (toleranties), DIN 2695 (dichtingen), EN 10222 (voormateriaal), EN 10216 en 10217 (buizen)

Uitvoeringen en codes

Type 01: Vlakke aanlasflens (voorheen DIN 2573 / 2576)

Type 02: Overschuifflens (voorheen DIN 2641 / 2642)

Type 05: Blindflens (voorheen DIN 2527)

Type 11: Voorlasflens (voorheen DIN 2632 / 2633 / 2634 / 2635 etc.)

Type 13: Draadflens (voorheen DIN 2566)

Type 33/37: Booring / laskraag t.b.v. overschuifflens

Overige type flenzen zijn geen onderdeel van het standaard pakket van S.K.S., maar op aanvraag wel leverbaar.

Bouten en moeren (EN 1515-1 en EN 1515-2)

De toegepaste bouten en moeren bepalen de sterkte van de verbinding en dienen gekozen te worden op basis van toegepaste druk en toegepast materiaal van de flenzen.

Afdichtingen (EN 1514)

Er zijn heel veel soorten en merken afdichtingen mogelijk voor een flensverbinding. Degene die S.K.S. standaard levert zijn: CR65 (natuurrubber), Uniflon (PTFE basis), Novus 34 (Hittebestendig) en de veel gebruikte grafietpakking.

Certificaten

3.1 certificaat Volgens EN 10204



BOORDRING MET ALUMINIUM FLENZEN ISO

DN / MM	A	B	Collar 304	Collar 316	Flange Alu.	Flange Alu. Coated
10 / 17,2	17,2	2	52134111	52138111	62301010	62601010
15 / 21,3	21,3	2	52134159	52138159	62301015	62601015
20 / 26,9	26,9	2,0	52134223	52138223	62301020	62601020
25 / 33,7	33,7	2,0	52134296	52138296	62301025	62601025
32 / 42,4	42,4	2,0	52134383	52138383	62301032	62601032
40 / 48,3	48,3	2,0	52134428	52138428	62301040	62601040
50 / 60,3	60,3	2,0	52134519	52138519	62301050	62601050
65 / 76,1	76,1	2,0	52134594	52138594	62301065	62601065
80 / 88,9	88,9	2,0	52134640	52138640	62301080	62601080
100 / 114,3	114,3	2,0	52134722	52138722	62301100	62601100
125 / 139,7	139,7	2,0	52134774	52138774	62301125	62601125
150 / 168,3	168,3	2,0	52134807	52138807	62301150	62601150
200 / 219,1	219,1	2,0	52134848	52138848	62301200	62601200
300 / 323,9	323,9	3,0	52134917	52138917	62301300	62601300

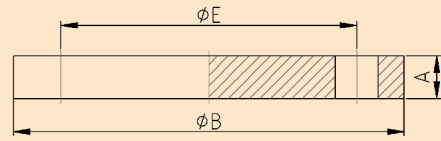

BOORDRING MET ALUMINIUM FLENZEN METRISCH

DN / MM	A	B	Collar 304	Collar 316	Flange Alu.	Flange Alu. Coated
20 / 25	25,0	2,0	52134201	52138201	62101020	62401020
25 / 28	28,0	1,5	52134241	52138241	62101025	62401025
25 / 30	30,0	2,0	52134259	52138259	62101025	62401025
25 / 32	32,0	2,0	52134279	52138279	62101025	62401025
32 / 35	35,0	2,0	52134312	52138312	62101032	62401032
32 / 38	38,0	1,5	52134338	52138338	62101032	62401032
32 / 40	40,0	2,0	52134363	52138363	62101040	62401040
40 / 44,5	44,5	2,0	52134404	52138404	62101040	62401040
50 / 51	51,0	1,5	52134461	52138461	62101050	62401050
50 / 54	54,0	2,0	52134482	52138482	62101050	62401050
65 / 70	70,0	2,0	52134566	52138566	62101065	62401065
80 / 84	84,0	2,0	52134630	52138630	62101080	62401080
100 / 104	104,0	2,0	52134694	52138694	62101100	62401100
125 / 129	129,0	2,0	52134754	52138754	62101125	62401125
150 / 154	154,0	2,0	52134790	52138790	62101150	62401150
200 / 204	204,0	2,0	52134834	52138834	62101200	62401200
250 / 254	254,0	2,0	52134867	52138867	62101250	62401250
300 / 304	304,0	2,0	52134901	52138901	62101300	62401300
350 / 356	356,0	3,0	52134930	52138930	62101350	62401350
400 / 406	406,0	3,0	52134940	52138940	62101400	62401400
500 / 506	506,0	3,0	52134966	52138966	62101500	62401500
600 / 606	606,0	3,0	52134969	52138969	62101600	62401600

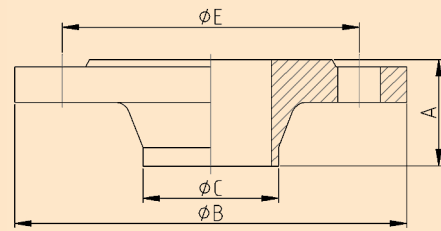

BLINDFLENS ALUMINIUM EN 1092-1 TYPE 05

DN	A	B	E	nr. Bolts	holes	Kg	Blank	Epox. Coating
10	12,0	85,0	55	4	14	0,17	63101010	63201010
15	12,0	95,0	65	4	14	0,19	63101015	63201015
20	12,0	105,0	75	4	14	0,22	63101020	63201020
25	12,0	115,0	85	4	14	0,27	63101025	63201025
32	16,0	140,0	100	4	18	0,54	63101032	63201032
40	16,0	150,0	110	4	18	0,61	63101040	63201040
50	16,0	165,0	125	4	18	0,73	63101050	63201050
65	16,0	185,0	145	8	18	0,90	63101065	63201065
80	18,0	200,0	160	8	18	1,05	63101080	63201080
100	18,0	220,0	180	8	18	1,20	63101100	63201100
125	18,0	250,0	210	8	18	1,50	63101125	63201125
150	18,0	285,0	240	8	22	1,90	63101150	63201150
200	20,0	340,0	295	8	22	2,70	63101200	63201200
300	22,0	445,0	400	12	22	4,20	63101300	63201300

**VOORLASFLENS EN1092-1 TYPE 11 PN10-40**

DN / C	A	B	nr.bolts	D	E	Kg	304 (L)	316L
10 / 17,2	35	90	4	14	60	0,7	66314013	66318013
15 / 21,3	38	95	4	14	65	0,8	66314018	66318018
20 / 26,9	40	105	4	14	75	1,1	66314024	66318024
25 / 33,7	40	115	4	14	85	1,3	66314029	66318029
32 / 42,4	42	140	4	18	100	1,9	66314035	66318035
40 / 48,3	45	150	4	18	110	2,3	66314044	66318044

VOORLASFLENS EN1092-1 TYPE 11 PN10-16

DN / C	A	B	nr.bolts	D	E	Kg	304 (L)	316L
50 / 60,3	45	165	4	18	125	2,5	66314057	66318057
65 / 76,1	45	185	4	18	145	3,1	66314071	66318071
65 / 76,1	45	185	8	18	145	3,1	66314069	66318069
80 / 88,9	50	200	8	18	160	3,7	66314084	66318084
100 / 114,3	52	220	8	18	180	4,6	66314106	66318106
125 / 139,7	55	250	8	18	210	6,3	66314130	66318130
150 / 168,3	55	285	8	22	240	7,8	66314156	66318156

VOORLASFLENS EN1092-1 TYPE 11 PN40

DN / C	A	B	nr.bolts	D	E	Kg	304 (L)	316L
50 / 60,3	48	165	4	18	125	2,8	66314055	66318056
65 / 76,1	52	185	8	18	145	3,7	66314068	66318068
80 / 88,9	58	200	8	18	160	4,8	66314083	66318085
100 / 114,3	65	235	8	22	190	6,5	66314105	66318105
125 / 139,7	68	270	8	26	220	9,1	66314131	66318131
150 / 168,3	75	300	8	26	250	11,8	66314155	66318155

VOORLASFLENS EN1092-1 TYPE 11 PN10

DN / C	A	B	nr.bolts	D	E	Kg	304 (L)	316L
200 / 219,1	62	340	8	22	295	11,3	66314203	66318203
250 / 273	68	395	12	22	350	14,7	66314251	66318251
300 / 323,9	68	445	12	22	400	17,4	66314305	66318305
350 / 355,6	68	505	16	22	460	23,6	66314351	66318351
400 / 406	72	565	16	26	515	28,6	66314402	66318402
500 / 508	75	670	20	26	620	38,1	66314500	66318500

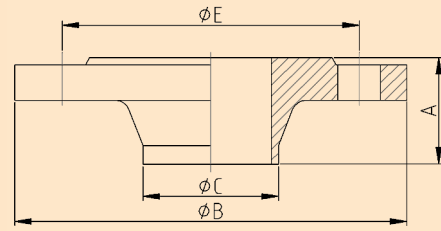

VOORLASFLENS EN1092-1 TYPE 11 PN16

DN / C	A	B	nr.bolts	D	E	Kg	304 (L)	316L
200 / 219,1	62	340	12	22	295	11	66314206	66318206
250 / 273	70	405	12	26	355	13	66314256	66318256
300 / 323,9	78	460	12	26	410	22	66314306	66318306

VOORLASFLENS EN1092-1 TYPE 11 PN10-40

DN / C	A	B	nr.bolts	D	E	Kg	304 (L)	316L
15 / 20	38	95	4	14	65	0,8	66314020	66318020
25 / 29	40	115	4	14	85	1,3	66314027	66318027
25 / 30	40	115	4	14	85	1,3	66314030	66318030
32 / 34	42	140	4	18	100	1,9	66314033	66318033
40 / 44,5	45	150	4	18	110	2,3	66314042	66318042
40 / 40	45	150	4	18	110	2,3	66314040	66318040

VOORLASFLENS EN1092-1 TYPE 11 PN10-16

DN / C	A	B	nr.bolts	D	E	Kg	304 (L)	316L
50 / 54	45	165	4	18	125	2,5	66314050	66318050
65 / 70	45	185	4	18	145	3,1	66314072	66318072
65 / 70	45	185	8	18	145	3,1	66314070	66318070
80 / 84	50	200	8	18	160	3,7	66314080	66318081
100 / 104	52	220	8	18	180	4,6	66314100	66318102
125 / 129	55	250	8	18	210	6,3	66314125	66318125
150 / 154	55	285	8	22	240	7,8	66314151	66318151

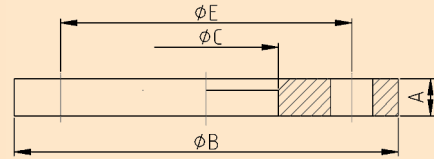
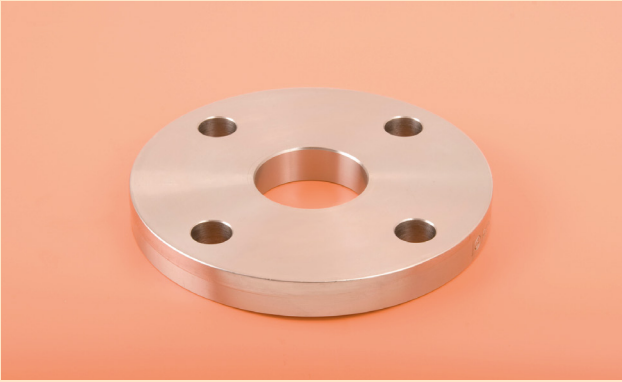
**VLAKKE LASFLENS EN1092-1 TYPE 01 PN10-40**

DN / C	A	B	C	nr.bolts	D	E	Kg	304 (L)	316L
10 / 17,2	16	90	17,2	4	14	60	0,7	672140121	672180121
15 / 21,3	16	95	21,3	4	14	65	0,8	672140171	672180171
20 / 26,9	18	105	26,9	4	14	75	1,1	672140231	672180231
25 / 33,7	18	115	33,7	4	14	85	1,3	672140281	672180281
32 / 42,4	18	140	42,4	4	18	100	1,9	672140341	672180341
40 / 48,3	18	150	48,3	4	18	110	2,3	672140431	672180431

VLAKKE LASFLENS EN1092-1 TYPE 01 PN10-16

DN / C	A	B	C	nr.bolts	D	E	Kg	304 (L)	316L
50 / 60,3	20	165	60,3	4	18	125	2,5	67214056	67218056
65 / 76,1	20	185	76,1	4	18	145	3,1	67214071	67218071
65 / 76,1	20	185	76,1	8	18	145	3,1	67214069	67218069
80 / 88,9	20	200	88,9	8	18	160	3,7	67214084	67218084
100 / 114,3	20	220	114,3	8	18	180	4,6	67214106	67218106
125 / 139,7	22	250	139,7	8	18	210	6,3	67214130	67218130
150 / 168,3	24	285	168,3	8	22	240	7,8	67214156	67218156

VLAKKE LASFLENS EN1092-1 TYPE 01 PN40

DN / C	A	B	C	nr.bolts	D	E	Kg	304 (L)	316L
50 / 60,3	20	165	60,3	4	18	125	2,8	67214055	67218057
65 / 76,1	22	185	76,1	8	18	145	3,7	67214073	67218073
80 / 88,9	24	200	88,9	8	18	160	4,8	67214088	67218088
100 / 114,3	26	235	114,3	8	22	190	6,5	67214107	67218107
125 / 139,7	28	270	139,7	8	26	220	9,1	67214131	67218131
150 / 168,3	30	300	168,3	8	26	250	11,8	67214157	67218155

VLAKKE LASFLENS EN1092-1 TYPE 01 PN10

DN / C	A	B	C	nr.bolts	D	E	Kg	304 (L)	316L
200 / 219,1	24	340	219,1	8	22	295	11,3	67214205	67218205
250 / 254	26	395	254	12	22	350	14,7	67214251	67218251
250 / 273	26	395	273	12	22	350	14,7	67214256	67218256
300 / 323,9	26	445	323,9	12	22	400	17,4	67214329	67218302
350 / 355,6	26	505	355,6	16	22	460	23,6	67214356	67218356
400 / 406	26	565	406	16	26	515	28,6	67214402	67218402
500 / 508	28	670	508	20	26	620	38,1	67214502	67218502

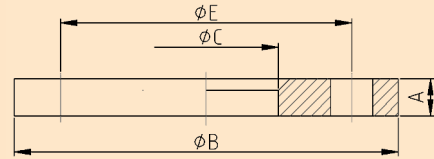
**VLAKKE LASFLENS EN1092-1 TYPE 01 PN16**

DN / C	A	B	C	nr.bolts	D	E	Kg	304 (L)	316L
200 / 219,1	24	340	219,1	12	22	295	11	67214206	67218206
250 / 273	26	405	273	12	26	355	13	67214257	67218252
300 / 323,9	28	460	323,9	12	26	410	22	67214306	67218306

VLAKKE LASFLENS EN1092-1 TYPE 01 PN10-40

DN / C	A	B	C	nr.bolts	D	E	Kg	304 (L)	316L
15 / 19	16	95	19	4	14	65	0,8	67214018	67218018
25 / 29	18	115	29	4	14	85	1,3	67214027	67218027
25 / 30	18	115	30	4	14	85	1,3	67214030	67218030
32 / 34	18	140	34	4	18	100	1,9	67214036	67218036
40 / 44,5	18	150	44,5	4	18	110	2,3	67214042	67218042
40 / 41	18	150	41	4	18	110	2,3	67214044	67218044

VLAKKE LASFLENS EN1092-1 TYPE 01 PN10-16

DN / C	A	B	C	nr.bolts	D	E	Kg	304 (L)	316L
50 / 54	18	165	54	4	18	125	2,5	67214052	67218052
65 / 70	18	185	70	4	18	145	3,1	67214066	67218066
65 / 70	18	185	70	8	18	145	3,1	67214072	67218072
80 / 84	20	200	84	8	18	160	3,7	67214086	67218086
80 / 76,1	20	200	76,1	8	18	160	3,7	67214085	67218085
100 / 104	20	220	104	8	18	180	4,6	67214102	67218102
125 / 129	22	250	129	8	18	210	6,3	67214126	67218126
150 / 154	24	285	154	8	22	240	7,8	67214151	67218151
200 / 204	24	340	204	8	22	295	11,3	67214201	67218201

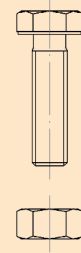

TAPBOUTEN DIN 933 AISI 304

Lengte	M5	M6	M8	M10	M12	M14	M16	M20	M24
10	91233202	91233241	91233310						
20	91233205	91233244	91233313	91233361	91233411				
25	91233206	91233245	91233314	91233362	91233412	91233463	91233510		
30	91233207	91233246	91233315	91233363	91233413	91233464	91233511	91233610	
40	91233209	91233248	91233317	91233365	91233415	91233466	91233513	91233612	91233710
50	91233211	91233250	91233319	91233367	91233417	91233468	91233515	91233614	91233712
60		91233252	91233321	91233369	91233419	91233470	91233517	91233616	91233714
70		91233254	91233323	91233371	91233421	91233472	91233519	91233618	91233716
80			91233325	91233373	91233423	91233475	91233521	91233920	91233718

MOEREN ETC.

Maat	hex nut DIN934	check nut DIN985	flat washer DIN125A	spring washer DIN127B	wing nut	ball nut
M5	92133190	92433190		96533190	92233190	92333190
M6	92133230	92433230		96533230	92233230	92333230
M8	92133300	92433300		96533300	92233300	92333300
M10	92133350	92433350		96533350	92233350	92333350
M12	92133400	92433400		96533400	92233400	92333400
M14	92133450	92433450		96533450	92233450	92333450
M16	92133500	92433500		96533500	92233500	92333500
M18	92133550	92433550		96533550	92233550	92333550
M20	92133600	92433600		96533600	92233600	92333600
M22	92133650	92433650		96533650	92233650	92333650

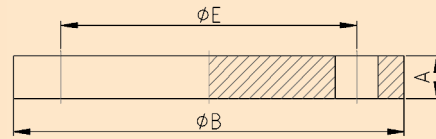
**BLINDFLENS EN1092-1 TYPE 05 PN10-40**

DN / C	A	B	nr.bolts	D	E	Kg	304 (L)	316L
10	16	90	4	14	60	0,38	65314011	65318011
15	16	95	4	14	65	0,44	65314016	65318016
20	18	105	4	14	75	0,56	65314021	65318021
25	18	115	4	14	85	0,82	65314026	65318026
32	18	140	4	18	100	1,2	65314033	65318033
40	18	150	4	18	110	1,4	65314041	65318041

BLINDFLENS EN1092-1 TYPE 05 PN10-16

DN / C	A	B	nr.bolts	D	E	Kg	304 (L)	316L
50	18	165	4	18	125	2	65314052	65318052
65	18	185	4	18	145	3,5	65314064	65318064
65	18	185	8	18	145	3,5	65314067	65318067
80	20	200	8	18	160	4,5	65314082	65318082
100	20	220	8	18	180	5,5	65314102	65318102
125	22	250	8	18	210	8	65314127	65318127
150	22	285	8	22	240	10,5	65314152	65318152

BLINDFLENS EN1092-1 TYPE 05 PN25-40

DN / C	A	B	nr.bolts	D	E	Kg	304 (L)	316L
50	20	165	4	18	125	3,2	65314051	65318053
65	22	185	8	18	145	4,3	65314068	65318068
80	24	200	8	18	160	5,9	65314083	65318083
100	26	235	8	22	190	7,5	65314103	65318103
125	28	270	8	26	220	10,8	65314128	65318128
150	30	300	8	26	250	14,5	65314151	65318151

BLINDFLENS EN1092-1 TYPE 05 PN10

DN	A	B	nr.bolts	D	E	Kg	304 (L)	316L
200	24	340	8	22	295	16,5	65314201	65318201
250	26	395	12	22	350	24	65314251	65318251
300	26	445	12	22	400	30,9	65314305	65318305
350	26	505	16	22	460	40,6	65314351	65318351
400	26	565	16	26	515	49,4	65314401	65318401
500	28	670	20	26	620	75	65314501	65318501

BLINDFLENS EN1092-1 TYPE 05 PN16

DN	A	B	nr.bolts	D	E	Kg	304 (L)	316L
200	24	340	12	22	295	16,1	65314202	65318202
250	26	405	12	26	355	24,9	65314252	65318252
300	28	460	12	26	410	35,1	65314306	65318306

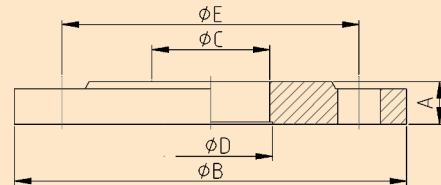
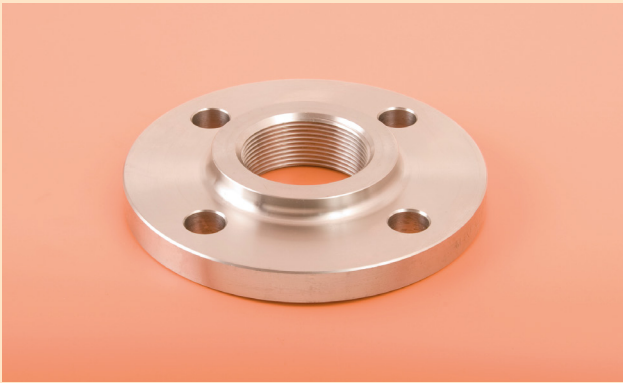
**DRAADFLENS EN 1092-1 TYPE 13 PN10/16**

DN	A	B	C	nr. Bolts	D	E	Kg	304(L)	316L
10	20	90	0,375"	4	14	60	0,54	68514013	68518013
15	20	95	0,5"	4	14	65	0,61	68514019	68518019
20	24	105	0,75"	4	14	75	0,91	68514024	68518024
25	24	115	1"	4	14	85	1,10	68514030	68518030
32	26	140	1,25"	4	18	100	1,60	68514035	68518035
40	26	150	1,5"	4	18	110	1,78	68514045	68518045
50	28	165	2"	4	18	125	2,43	68514057	68518057
65	32	185	2,5"	4	18	145	3,18	68514071	68518071
80	34	200	3"	8	18	160	4,12	68514090	68518090
100	38	220	4"	8	18	180	4,47	68514108	68518108

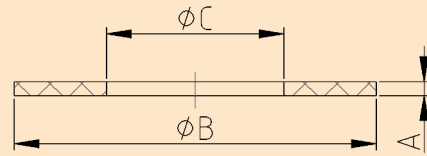

FLENSPAKKING ISO (EN 1092) METRISCH

DN	A	B	C	Kg	Grafiet	Novus	PTFE (Gylon)
10	2	46	18	0,001	67600012	67700012	67800012UN
15	2	51	22	0,001	67600017	67700017	67800017UN
20	2	61	27	0,002	67600023	67700023	67800023UN
25	2	71	34	0,003	67600028	67700028	67800028UN
32	2	82	43	0,004	67600034	67700034	67800034UN
40	2	92	49	0,005	67600043	67700043	67800043UN
50	2	107	61	0,006	67600054	67700054	67800054UN
65	2	127	77	0,008	67600067	67700067	67800067UN
80	2	142	89	0,011	67600082	67700082	67800082UN
100	2	162	115	0,012	67600104	67700104	67800104UN
125	2	168	141	0,015	67600128	67700128	67800128UN
150	2	218	169	0,022	67600154	67700154	67800154UN
200	2	273	220	0,034	67600204	67700204	67800204UN
250	2	328	273	0,045	67600254	67700254	67800254UN
300	2	378	324	0,055	67600304	67700304	67800304UN



Walserijproducten

Op de plaatsen waar leidingcomponenten worden verwerkt, is het gebruik van walserijproducten voor de constructie onvermijdelijk. Enkele voorbeelden hiervoor zijn de leidingbrug, een bordes rondom een tank of het frame van een skid. Om ook in deze behoefte te kunnen voorzien, heeft S.K.S. een afgestemd assortiment waarvan een groot deel uit voorraad leverbaar is.

Het pakket walserijproducten bestaat bij S.K.S. uit

- Kokerprofiel vierkant
- Kokerprofiel rechthoek
- Platstaf warmgewalst (variabele lengtes tussen ca. 3.5 en 5 meter)
- Platstaf geslit (handelslengte van 4 meter)
- Rondstaf getrokken H9
- Rondstaf warmgewalst, geschild

- Hoekprofiel gelijkzijdig (handelslengte ca. 6 meter)
- Plaat koudgewalst (handelsafmeting 2000x1000 mm)
- Plaat geperforeerd (handelsafmeting 2000x1000 mm)
- Vierkant staf warmgewalst (variabele lengtes tussen ca. 3.5 en 5 meter)
- Zeskant staf warmgewalst (variabele lengtes tussen ca. 3.5 en 5 meter)

Hoewel het vrijwel niet gevraagd wordt, is het mogelijk om deze materialen inclusief een 3.1 certificaat geleverd te krijgen.

Voor een uitgebreid overzicht van de leveringsomvang verwijzen wij u naar de brochures voor industriële installatie materialen (EN DIN of ANSI ASTM).

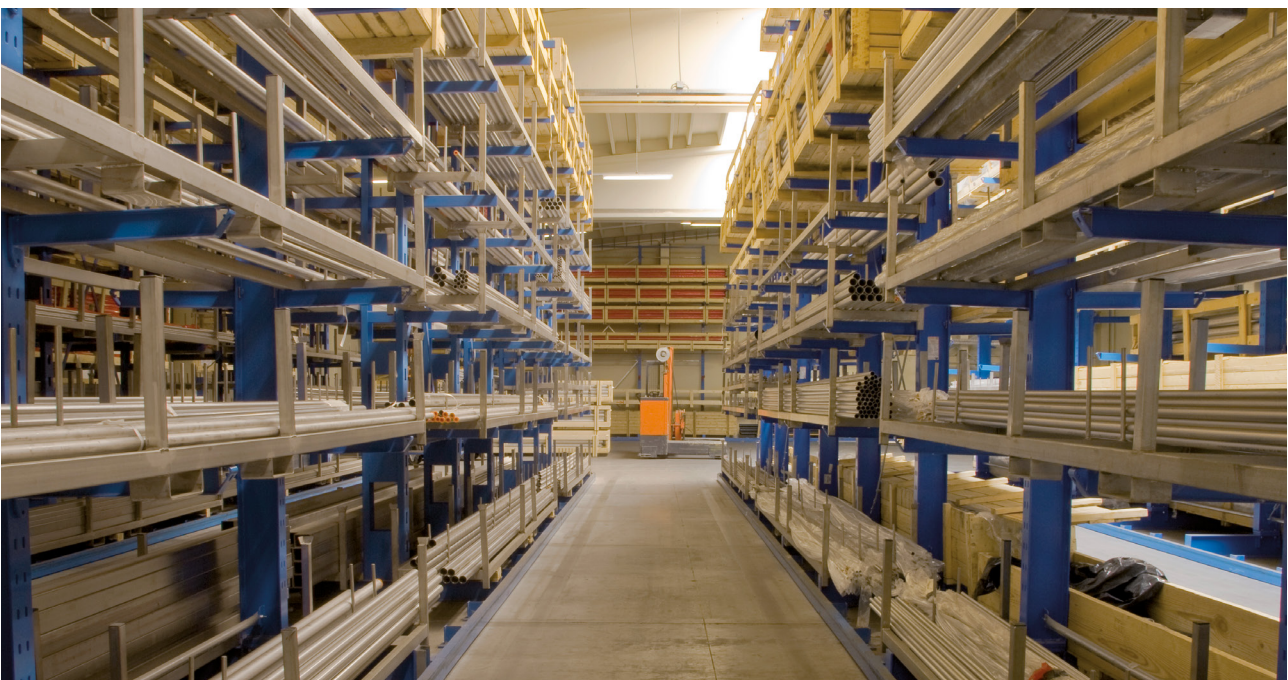

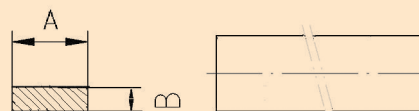

STAFSTAAL PLAT GESLIT

MM	A	B	C	D	Length	Kg	304(L)	316(L)
15 x 3,0	15	3,0			4 mtr	0,35	89233020	89236020
20 x 3,0	20	3,0			4 mtr	0,47	89233025	89236025
25 x 3,0	25	3,0			4 mtr	0,59	89233030	89236030
30 x 3,0	30	3,0			4 mtr	0,70	89233035	89236035
35 x 3,0	35	3,0			4 mtr	0,83	89233036	89236036
40 x 3,0	40	3,0			4 mtr	0,94	89233040	89236040
50 x 3,0	50	3,0			4 mtr	1,18	89233045	89236045
20 x 4,0	20	4,0			4 mtr	0,63	89233065	89236065
25 x 4,0	25	4,0			4 mtr	0,79	89233070	89236070
30 x 4,0	30	4,0			4 mtr	0,94	89233075	89236075
35 x 4,0	35	4,0			4 mtr	1,10	89233080	89236080
40 x 4,0	40	4,0			4 mtr	1,26	89233085	89236085
50 x 4,0	50	4,0			4 mtr	1,57	89233090	89236090
60 x 4,0	60	4,0			4 mtr	1,88	89233095	89236095
15 x 5,0	15	5,0			4 mtr	0,59	89233110	89236110
20 x 5,0	20	5,0			4 mtr	0,79	89233120	89236120
25 x 5,0	25	5,0			4 mtr	0,98	89233125	89236125
30 x 5,0	30	5,0			4 mtr	1,18	89233130	89236130
35 x 5,0	35	5,0			4 mtr	1,37	89233140	89236140
40 x 5,0	40	5,0			4 mtr	1,57	89233145	89236145
45 x 5,0	45	5,0			4 mtr	1,77	89233150	89236150
50 x 5,0	50	5,0			4 mtr	1,96	89233155	89236155
60 x 5,0	60	5,0			4 mtr	2,36	89233160	89236160
65 x 5,0	65	5,0			4 mtr	2,55	89233162	89236162
70 x 5,0	70	5,0			4 mtr	2,75	89233170	89236170
75 x 5,0	75	5,0			4 mtr	2,94	89233175	89236175
80 x 5,0	80	5,0			4 mtr	3,14	89233180	89236180
100 x 5,0	100	5,0			4 mtr	3,93	89233190	89236190
120 x 5,0	120	5,0			4 mtr	4,71	89233200	89236200
20 x 6,0	20	6,0			4 mtr	0,94	89233210	89236210
25 x 6,0	25	6,0			4 mtr	1,18	89233215	89236215
30 x 6,0	30	6,0			4 mtr	1,41	89233220	89236220
35 x 6,0	35	6,0			4 mtr	1,65	89233230	89236230
40 x 6,0	40	6,0			4 mtr	1,88	89233240	89236240

vervolg tabel van pag. 67

MM	A	B	C	D	Length	Kg	304(L)	316(L)
45 x 6,0	45	6,0			4 mtr	2,12	89233245	89236245
50 x 6,0	50	6,0			4 mtr	2,36	89233250	89236250
60 x 6,0	60	6,0			4 mtr	2,83	89233255	89236255
70 x 6,0	70	6,0			4 mtr	3,30	89233265	89236265
75 x 6,0	75	6,0			4 mtr	3,53	89233270	89236270
80 x 6,0	80	6,0			4 mtr	3,77	89233275	89236275
90 x 6,0	90	6,0			4 mtr	4,24	89233280	89236280
100 x 6,0	100	6,0			4 mtr	4,71	89233285	89236285
120 x 6,0	120	6,0			4 mtr	5,65	89233295	89236295
20 x 8,0	20	8,0			4 mtr	1,26	89233320	89236320
25 x 8,0	25	8,0			4 mtr	1,57	89233325	89236325
30 x 8,0	30	8,0			4 mtr	1,88	89233330	89236330
35 x 8,0	35	8,0			4 mtr	2,20	89233340	89236340
40 x 8,0	40	8,0			4 mtr	2,51	89233345	89236345
45 x 8,0	45	8,0			4 mtr	2,83	89233350	89236350
50 x 8,0	50	8,0			4 mtr	3,14	89233355	89236355
60 x 8,0	60	8,0			4 mtr	3,77	89233360	89236360
70 x 8,0	70	8,0			4 mtr	4,40	89233370	89236370
75 x 8,0	75	8,0			4 mtr	4,71	89233375	89236375
80 x 8,0	80	8,0			4 mtr	5,02	89233380	89236380
90 x 8,0	90	8,0			4 mtr	5,65	89233385	89236385
100 x 8,0	100	8,0			4 mtr	6,28	89233390	89236390
150 x 8,0	150	8,0			4 mtr	9,42	89233395	89236395
20 x 10,0	20	10,0			4 mtr	1,57	89233430	89236430
25 x 10,0	25	10,0			4 mtr	1,96	89233435	89236435
30 x 10,0	30	10,0			4 mtr	2,36	89233440	89236440
35 x 10,0	35	10,0			4 mtr	2,75	89233450	89236450
40 x 10,0	40	10,0			4 mtr	3,14	89233455	89236455
45 x 10,0	45	10,0			4 mtr	3,53	89233460	89236460
50 x 10,0	50	10,0			4 mtr	3,93	89233465	89236465
60 x 10,0	60	10,0			4 mtr	4,71	89233475	89236475
70 x 10,0	70	10,0			4 mtr	5,50	89233485	89236485
75 x 10,0	75	10,0			4 mtr	5,89	89233490	89236490
80 x 10,0	80	10,0			4 mtr	6,28	89233495	89236495
90 x 10,0	90	10,0			4 mtr	7,07	89233500	89236500
100 x 10,0	100	10,0			4 mtr	7,85	89233505	89236505
110 x 10,0	110	10,0			4 mtr	8,64	89233510	89236510
120 x 10,0	120	10,0			4 mtr	9,42	89233515	89236515
150 x 10,0	150	10,0			4 mtr	11,77	89233530	89236530
200 x 10,0	200	10,0			4 mtr	15,70	89233533	89236533

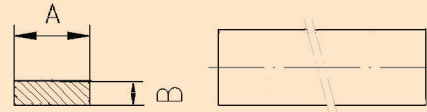

STAFSTAAL PLAT WARMGEWALST

MM	A	B	C	D	Length	Kg	304(L)	316(L)
20 x 4,0	20	4,0			3,5-5 mtr	0,63	89133065	89136065
25 x 4,0	25	4,0			3,5-5 mtr	0,79	89133070	89136070
30 x 4,0	30	4,0			3,5-5 mtr	0,94	89133075	89136075
35 x 4,0	35	4,0			3,5-5 mtr	1,10	89133080	89136080
40 x 4,0	40	4,0			3,5-5 mtr	1,26	89133085	89136085
50 x 4,0	50	4,0			3,5-5 mtr	1,57	89133090	89136090
60 x 4,0	60	4,0			3,5-5 mtr	1,88	89133095	89136095
15 x 5,0	15	5,0			3,5-5 mtr	0,59	89133110	89136110
20 x 5,0	20	5,0			3,5-5 mtr	0,79	89133120	89136120
25 x 5,0	25	5,0			3,5-5 mtr	0,98	89133125	89136125
30 x 5,0	30	5,0			3,5-5 mtr	1,18	89133130	89136130
35 x 5,0	35	5,0			3,5-5 mtr	1,37	89133140	89136140
40 x 5,0	40	5,0			3,5-5 mtr	1,57	89133145	89136145
45 x 5,0	45	5,0			3,5-5 mtr	1,77	89133150	89136150
50 x 5,0	50	5,0			3,5-5 mtr	1,96	89133155	89136155
60 x 5,0	60	5,0			3,5-5 mtr	2,36	89133160	89136160
65 x 5,0	65	5,0			3,5-5 mtr	2,55	89133162	89136162
70 x 5,0	70	5,0			3,5-5 mtr	2,75	89133170	89136170
75 x 5,0	75	5,0			3,5-5 mtr	2,94	89133175	89136175
80 x 5,0	80	5,0			3,5-5 mtr	3,14	89133180	89136180
100 x 5,0	100	5,0			3,5-5 mtr	3,93	89133190	89136190
120 x 5,0	120	5,0			3,5-5 mtr	4,71	89133200	89136200
20 x 6,0	20	6,0			3,5-5 mtr	0,94	89133210	89136210
25 x 6,0	25	6,0			3,5-5 mtr	1,18	89133215	89136215
30 x 6,0	30	6,0			3,5-5 mtr	1,41	89133220	89136220
35 x 6,0	35	6,0			3,5-5 mtr	1,65	89133230	89136230
40 x 6,0	40	6,0			3,5-5 mtr	1,88	89133240	89136240
45 x 6,0	45	6,0			3,5-5 mtr	2,12	89133245	89136245
50 x 6,0	50	6,0			3,5-5 mtr	2,36	89133250	89136250
60 x 6,0	60	6,0			3,5-5 mtr	2,83	89133255	89136255
70 x 6,0	70	6,0			3,5-5 mtr	3,30	89133265	89136265
75 x 6,0	75	6,0			3,5-5 mtr	3,53	89133270	89136270
80 x 6,0	80	6,0			3,5-5 mtr	3,77	89133275	89136275
90 x 6,0	90	6,0			3,5-5 mtr	4,24	89133280	89136280
100 x 6,0	100	6,0			3,5-5 mtr	4,71	89133285	89136285
120 x 6,0	120	6,0			3,5-5 mtr	5,65	89133295	89136295

MM	A	B	C	D	Length	Kg	304(L)	316(L)
20 x 8,0	20	8,0			3,5-5 mtr	1,26	89133320	89136320
25 x 8,0	25	8,0			3,5-5 mtr	1,57	89133325	89136325
30 x 8,0	30	8,0			3,5-5 mtr	1,88	89133330	89136330
35 x 8,0	35	8,0			3,5-5 mtr	2,20	89133340	89136340
40 x 8,0	40	8,0			3,5-5 mtr	2,51	89133345	89136345
45 x 8,0	45	8,0			3,5-5 mtr	2,83	89133350	89136350
50 x 8,0	50	8,0			3,5-5 mtr	3,14	89133355	89136355
60 x 8,0	60	8,0			3,5-5 mtr	3,77	89133360	89136360
70 x 8,0	70	8,0			3,5-5 mtr	4,40	89133370	89136370
75 x 8,0	75	8,0			3,5-5 mtr	4,71	89133375	89136375
80 x 8,0	80	8,0			3,5-5 mtr	5,02	89133380	89136380
90 x 8,0	90	8,0			3,5-5 mtr	5,65	89133385	89136385
100 x 8,0	100	8,0			3,5-5 mtr	6,28	89133390	89136390
150 x 8,0	150	8,0			3,5-5 mtr	9,42	89133395	89136395
20 x 10,0	20	10,0			3,5-5 mtr	1,57	89133430	89136430
25 x 10,0	25	10,0			3,5-5 mtr	1,96	89133435	89136435
30 x 10,0	30	10,0			3,5-5 mtr	2,36	89133440	89136440
35 x 10,0	35	10,0			3,5-5 mtr	2,75	89133450	89136450
40 x 10,0	40	10,0			3,5-5 mtr	3,14	89133455	89136455
45 x 10,0	45	10,0			3,5-5 mtr	3,53	89133460	89136460
50 x 10,0	50	10,0			3,5-5 mtr	3,93	89133465	89136465
60 x 10,0	60	10,0			3,5-5 mtr	4,71	89133475	89136475
70 x 10,0	70	10,0			3,5-5 mtr	5,50	89133485	89136485
75 x 10,0	75	10,0			3,5-5 mtr	5,89	89133490	89136490
80 x 10,0	80	10,0			3,5-5 mtr	6,28	89133495	89136495
90 x 10,0	90	10,0			3,5-5 mtr	7,07	89133500	89136500
100 x 10,0	100	10,0			3,5-5 mtr	7,85	89133505	89136505
110 x 10,0	110	10,0			3,5-5 mtr	8,64	89133510	89136510
120 x 10,0	120	10,0			3,5-5 mtr	9,42	89133515	89136515
150 x 10,0	150	10,0			3,5-5 mtr	11,77	89133530	89136530
200 x 10,0	200	10,0			3,5-5 mtr	15,70	89133533	89136533
20 x 12,0	20	12,0			3,5-5 mtr	1,88	89133535	89136535
25 x 12,0	25	12,0			3,5-5 mtr	2,36	89133540	89136540
30 x 12,0	30	12,0			3,5-5 mtr	2,83	89133550	89136550
35 x 12,0	35	12,0			3,5-5 mtr	3,30	89133555	89136555
40 x 12,0	40	12,0			3,5-5 mtr	3,77	89133560	89136560
50 x 12,0	50	12,0			3,5-5 mtr	4,71	89133570	89136570
60 x 12,0	60	12,0			3,5-5 mtr	5,65	89133580	89136580
70 x 12,0	70	12,0			3,5-5 mtr	6,60	89133585	89136585
75 x 12,0	75	12,0			3,5-5 mtr	7,07	89133590	89136590
80 x 12,0	80	12,0			3,5-5 mtr	7,54	89133595	89136595
100 x 12,0	100	12,0			3,5-5 mtr	9,42	89133605	89136605
20 x 15,0	20	15,0			3,5-5 mtr	2,36	89133628	89136628
25 x 15,0	25	15,0			3,5-5 mtr	2,94	89133629	89136629
30 x 15,0	30	15,0			3,5-5 mtr	3,53	89133640	89136640
35 x 15,0	35	15,0			3,5-5 mtr	4,12	89133645	89136645
40 x 15,0	40	15,0			3,5-5 mtr	4,71	89133630	89136630

MM	A	B	C	D	Length	Kg	304(L)	316(L)
50 x 15,0	50	15,0			3,5-5 mtr	5,89	89133660	89136660
60 x 15,0	60	15,0			3,5-5 mtr	7,07	89133670	89136670
70 x 15,0	70	15,0			3,5-5 mtr	8,24	89133675	89136675
75 x 15,0	75	15,0			3,5-5 mtr	8,83	89133680	89136680
80 x 15,0	80	15,0			3,5-5 mtr	9,42	89133685	89136685
100 x 15,0	100	15,0			3,5-5 mtr	11,77	89133695	89136695
120 x 15,0	120	15,0			3,5-5 mtr	14,13	89133700	89136700
150 x 15,0	150	15,0			3,5-5 mtr	17,66	89133707	89136707
25 x 20,0	25	20,0			3,5-5 mtr	3,93	89133710	89136710
30 x 20,0	30	20,0			3,5-5 mtr	4,71	89133715	89136715
40 x 20,0	40	20,0			3,5-5 mtr	6,25	89133725	89136725
50 x 20,0	50	20,0			3,5-5 mtr	7,85	89133735	89136735
60 x 20,0	60	20,0			3,5-5 mtr	9,42	89133745	89136745
70 x 20,0	70	20,0			3,5-5 mtr	10,99	89133750	89136750
80 x 20,0	80	20,0			3,5-5 mtr	12,56	89133760	89136760
100 x 20,0	100	20,0			3,5-5 mtr	15,70	89133770	89136770
30 x 25,0	30	25,0			3,5-5 mtr	5,89	89133790	89136790
40 x 25,0	40	25,0			3,5-5 mtr	7,85	89133795	89136795
50 x 25,0	50	25,0			3,5-5 mtr	9,81	89133805	89136805
60 x 25,0	60	25,0			3,5-5 mtr	11,78	89133810	89136810
70 x 25,0	70	25,0			3,5-5 mtr	13,74	89133815	89136815
80 x 25,0	80	25,0			3,5-5 mtr	15,60	89133825	89136825
100 x 25,0	100	25,0			3,5-5 mtr	19,63	89133835	89136835
150 x 25,0	150	25,0			3,5-5 mtr	29,44	89133837	89136837
40 x 30,0	40	30,0			3,5-5 mtr	9,42	89133840	89136840
50 x 30,0	50	30,0			3,5-5 mtr	11,78	89133850	89136850
60 x 30,0	60	30,0			3,5-5 mtr	14,13	89133860	89136860
80 x 30,0	80	30,0			3,5-5 mtr	18,84	89133865	89136865
100 x 30,0	100	30,0			3,5-5 mtr	23,55	89133875	89136875
100 x 35,0	100	35,0			3,5-5 mtr	27,48	89133889	89136889
100 x 40,0	100	40,0			3,5-5 mtr	31,40	89133899	89136899
100 x 50,0	100	50,0			3,5-5 mtr	39,26	89133950	89136950
100 x 60,0	100	60,0			3,5-5 mtr	47,12	89133960	89136960

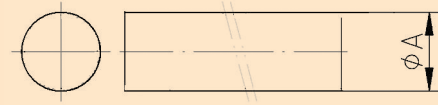

STAFSTAAL ROND GETROKKEN TOL. H9

MM	A	B	C	D	Length	Kg	304(L)	316(L)
3	3				3 mtr	0,056	89533024	89536024
4	4				3 mtr	0,099	89533032	89536032
5	5				3 mtr	0,154	89533040	89536040
6	6				3 mtr	0,222	89533048	89536048
8	8				3 mtr	0,395	89533064	89536064
9	9				3 mtr	0,499	89533072	89536072
10	10				3 mtr	0,617	89533080	89536080
12	12				3 mtr	0,888	89533096	89536096
13	13				3 mtr	1,042	89533104	89536104
14	14				3 mtr	1,208	89533112	89536112
15	15				3 mtr	1,387	89533120	89536120
16	16				3 mtr	1,578	89533128	89536128
17	17				3 mtr	1,782	89533136	89536136
18	18				3 mtr	1,998	89533144	89536144
19	19				3 mtr	2,226	89533152	89536152
20	20				3 mtr	2,466	89533160	89536160
22	22				3 mtr	2,984	89533168	89536168
25	25				3 mtr	3,853	89533192	89536192
28	28				3 mtr	4,834	89533208	89536208
30	30				3 mtr	5,549	89533216	89536216
32	32				3 mtr	6,313	89533232	89536232
35	35				3 mtr	7,553	89533248	89536248
38	38				3 mtr	8,903	89533265	89536265
40	40				3 mtr	9,865	89533280	89536280
45	45				3 mtr	12,49	89533304	89536304
48	48				3 mtr	14,21	89533314	89536314
50	50				3 mtr	15,41	89533320	89536320
55	55				3 mtr	18,65	89533344	89536344
60	60				3 mtr	22,2	89533368	89536368

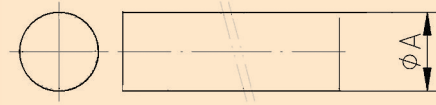

STAFSTAAL ROND WARMGEWALST, GESCHILD

MM	A	B	C	D	Length	Kg	304(L)	316(L)
50	50				var.	15,41	89433320	89436320
65	65				var.	26,05	89433384	89436384
70	70				var.	30,21	89433400	89436400
75	75				var.	34,68	89433416	89436416
80	80				var.	39,46	89433432	89436432
85	85				var.	44,55	89433448	89436448
90	90				var.	49,94	89433472	89436472
95	95				var.	55,64	89433496	89436496
100	100				var.	61,65	89433512	89436512
105	105				var.	67,97	89433528	89436528
110	110				var.	74,60	89433544	89436544
120	120				var.	88,78	89433560	89436560
125	125				var.	96,33	89433568	89436568
130	130				var.	104,20	89433584	89436584
135	135				var.	112,40	89433590	89436590
140	140				var.	120,80	89433600	89436600
150	150				var.	138,70	89433620	89436620
160	160				var.	157,80	89433650	89436650
180	180				var.	199,80	89433704	89436704
200	200				var.	246,60	89433744	89436744

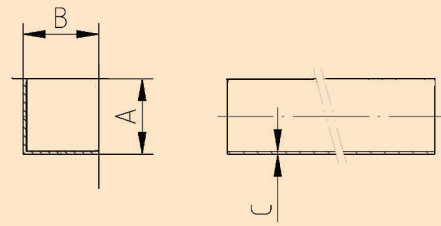

HOEKPROFIEL GELIJKZIJDIG

Maat	A	B	C	D	E	Kg	304(L)	316L
20 x 20	20,0	20,0	3,0			0,880	87133330	87136330
25 x 25	25,0	25,0	3,0			1,120	87133335	87136335
30 x 30	30,0	30,0	3,0			1,360	87133340	87136340
35 x 35	35,0	35,0	4,0			2,100	87133350	87136350
40 x 40	40,0	40,0	4,0			2,420	87133460	87136460
50 x 50	50,0	50,0	5,0			3,770	87133545	87136545
60 x 60	60,0	60,0	6,0			5,420	87133605	87136605
70 x 70	70,0	70,0	7,0			7,380	87133610	87136610
80 x 80	80,0	80,0	8,0			9,660	87133615	87136615
100 x 100	100,0	100,0	10,0			15,100	87133627	87136627

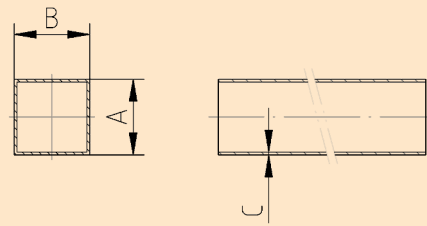

PROFIELBUIS VIERKANT EN 10219-1/2

Maat	A	B	C	D	E	Kg	304 mat	316 mat	304 polished	316 polished
10 x 10 x 1,0	10,0	10,0	1,0			0,320	86133011	86136011	86333011	86336011
15 x 15 x 1,5	15,0	15,0	1,5			0,660	86133044	86136044	86333044	86336044
20 x 20 x 1,5	20,0	20,0	1,5			0,883	86133112	86136112	86333112	86336112
20 x 20 x 2,0	20,0	20,0	2,0			1,152	86133114	86136114	86333114	86336114
25 x 25 x 1,2	25,0	25,0	1,2			1,000	86133144	86136144	86333144	86336144
25 x 25 x 1,5	25,0	25,0	1,5			1,146	86133146	86136146	86333146	86336146
25 x 25 x 2,0	25,0	25,0	2,0			1,495	86133148	86136148	86333148	86336148
30 x 30 x 1,5	30,0	30,0	1,5			1,371	86133166	86136166	86333166	86336166
30 x 30 x 2,0	30,0	30,0	2,0			1,840	86133168	86136168	86333168	86336168
30 x 30 x 3,0	30,0	30,0	3,0			2,720	86133172	86136172	86333172	86336172
35 x 35 x 1,5	35,0	35,0	1,5			1,620	86133229	86136229	86333229	86336229
35 x 35 x 2,0	35,0	35,0	2,0			2,150	86133231	86136231	86333231	86336231
40 x 40 x 1,5	40,0	40,0	1,5			1,859	86133275	86136275	86333275	86336275
40 x 40 x 2,0	40,0	40,0	2,0			2,454	86133277	86136277	86333277	86336277
40 x 40 x 3,0	40,0	40,0	3,0			3,756	86133281	86136281	86333281	86336281
40 x 40 x 4,0	40,0	40,0	4,0			4,880	86133283	86136283	86333283	86336283
45 x 45 x 2,0	45,0	45,0	2,0			2,750	86133302	86136302	86333302	86336302
50 x 50 x 1,5	50,0	50,0	1,5			2,329	86133324	86136324	86333324	86336324
50 x 50 x 2,0	50,0	50,0	2,0			3,080	86133327	86136327	86333327	86336327
50 x 50 x 3,0	50,0	50,0	3,0			4,650	86133331	86136331	86333331	86336331
50 x 50 x 4,0	50,0	50,0	4,0			5,997	86133333	86136333	86333333	86336333
50 x 50 x 5,0	50,0	50,0	5,0			7,320	86133335	86136335	86333335	86336335
60 x 60 x 2,0	60,0	60,0	2,0			3,711	86133348	86136348	86333348	86336348
60 x 60 x 3,0	60,0	60,0	3,0			5,491	86133352	86136352	86333352	86336352
60 x 60 x 5,0	60,0	60,0	5,0			8,910	86133356	86136356	86333356	86336356
70 x 70 x 3,0	70,0	70,0	3,0			6,494	86133375	86136375	86333375	86336375
80 x 80 x 2,0	80,0	80,0	2,0			4,988	86133394	86136394	86333394	86336394
80 x 80 x 3,0	80,0	80,0	3,0			7,530	86133398	86136398	86333398	86336398
100 x 100 x 2,0	100,0	100,0	2,0			6,400	86133440	86136440	86333440	86336440
100 x 100 x 3,0	100,0	100,0	3,0			9,530	86133444	86136444	86333444	86336444
100 x 100 x 4,0	100,0	100,0	4,0			12,600	86133446	86136446	86333446	86336446
100 x 100 x 5,0	100,0	100,0	5,0			15,624	86133448	86136448	86333448	86336448
120 x 120 x 3,0	120,0	120,0	3,0			11,415	86133494	86136494	86333494	86336494
120 x 120 x 4,0	120,0	120,0	4,0			15,120	86133496	86136496	86333496	86336496
120 x 120 x 5,0	120,0	120,0	5,0			18,774	86133498	86136498	86333498	86336498
150 x 150 x 3,0	150,0	150,0	3,0			13,820	86133569	86136569	86333569	86336569
150 x 150 x 5,0	150,0	150,0	5,0			22,400	86133573	86136573	86333573	86336573

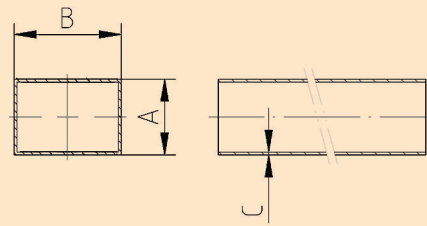
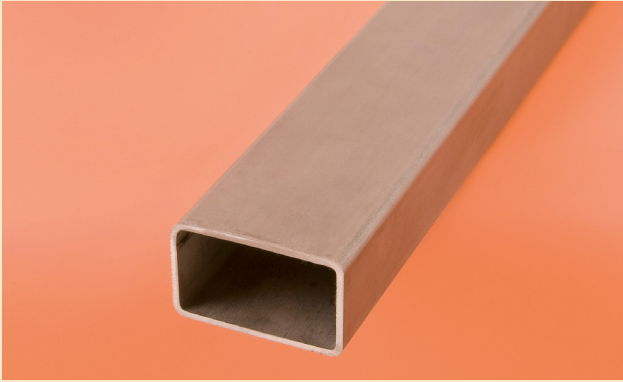

PROFIELBUIS RECHTHOEK EN 10219-1/2

Maat	A	B	C	D	E	Kg	304 mat	316 mat	304 polished	316 polished
20 x 10 x 1,5	20,0	10,0	1,5			0,660	86233010	86236010	86433010	86436010
20 x 15 x 1,5	20,0	15,0	1,5			0,774	86233016	86236016	86433016	86436016
25 x 15 x 1,5	25,0	15,0	1,5			0,883	86233036	86236036	86433036	86436036
30 x 15 x 1,5	30,0	15,0	1,5			0,995	86233068	86236068	86433068	86436068
30 x 20 x 1,5	30,0	20,0	1,5			1,146	86233080	86236080	86433080	86436080
30 x 20 x 2,0	30,0	20,0	2,0			1,495	86233082	86236082	86433082	86436082
40 x 15 x 1,5	40,0	15,0	1,5			1,260	86233150	86236150	86433150	86436150
40 x 20 x 1,5	40,0	20,0	1,5			1,371	86233164	86236164	86433164	86436164
40 x 20 x 2,0	40,0	20,0	2,0			1,840	86233166	86236166	86433166	86436166
40 x 30 x 1,5	40,0	30,0	1,5			1,620	86233206	86236206	86433206	86436206
40 x 30 x 2,0	40,0	30,0	2,0			2,150	86233208	86236208	86433208	86436208
50 x 20 x 2,0	50,0	20,0	2,0			2,150	86233281	86236281	86433281	86436281
50 x 25 x 1,5	50,0	25,0	1,5			1,758	83233293	86233293	83233293	83233293
50 x 25 x 2,0	50,0	25,0	2,0			2,319	86233295	86236295	86433295	86436295
50 x 30 x 1,5	50,0	30,0	1,5			1,859	86233307	86236307	86433307	86436307
50 x 30 x 2,0	50,0	30,0	2,0			2,454	86233309	86236309	86433309	86436309
50 x 30 x 3,0	50,0	30,0	3,0			3,756	86233311	86236311	86433311	86436311
60 x 30 x 1,5	60,0	30,0	1,5			2,122	86233383	86236383	86433383	86436383
60 x 30 x 2,0	60,0	30,0	2,0			2,804	86233385	86236385	86433385	86436385
60 x 30 x 3,0	60,0	30,0	3,0			4,040	86233387	86236387	86433387	86436387
60 x 40 x 1,5	60,0	40,0	1,5			2,329	86233395	86236395	86433395	86436395
60 x 40 x 2,0	60,0	40,0	2,0			3,080	86233397	86236397	86433397	86436397
60 x 40 x 3,0	60,0	40,0	3,0			4,650	86233399	86236399	86433399	86436399
80 x 40 x 2,0	80,0	40,0	2,0			3,711	86233497	86236497	86433497	86436497
80 x 40 x 3,0	80,0	40,0	3,0			5,491	86233501	86236501	86433501	86436501
80 x 60 x 2,0	80,0	60,0	2,0			4,380	86233524	86236524	86433524	86436524
80 x 60 x 3,0	80,0	60,0	3,0			6,530	86233525	86236525	86433525	86436525
80 x 60 x 4,0	80,0	60,0	4,0			8,557	86233526	86236526	86433526	86436526
100 x 40 x 2,0	100,0	40,0	2,0			4,380	86233559	86236559	86433559	86436559
100 x 40 x 3,0	100,0	40,0	3,0			6,530	86233561	86236561	86433561	86436561
100 x 50 x 2,0	100,0	50,0	2,0			4,680	86233569	86236569	86433569	86436569
100 x 50 x 3,0	100,0	50,0	3,0			6,864	86233573	86236573	86433573	86436573
100 x 50 x 4,0	100,0	50,0	4,0			9,173	86233575	86236575	86433575	86436575
100 x 50 x 5,0	100,0	50,0	5,0			11,270	86233577	86236577	86433577	86436577
100 x 60 x 2,0	100,0	60,0	2,0			4,960	86233585	86236585	86433585	86436585
100 x 60 x 3,0	100,0	60,0	3,0			7,344	86233589	86236589	86433589	86436589

Maat	A	B	C	D	E	Kg	304 mat	316 mat	304 polished	316 polished
100 x 60 x 4,0	100,0	60,0	4,0			9,780	86233591	86236591	86433591	86436591
100 x 80 x 3,0	100,0	80,0	3,0			8,304	86233607	86236607	86433607	86436607
100 x 80 x 5,0	100,0	80,0	5,0			13,200	86233609	86236609	86433609	86436609
120 x 40 x 3,0	120,0	40,0	3,0			7,410	86233653	86236653	86433653	86436653
120 x 60 x 2,0	120,0	60,0	2,0			5,659	86233665	86236665	86433665	86436665
120 x 60 x 3,0	120,0	60,0	3,0			8,414	86233669	86236669	86433669	86436669
120 x 60 x 4,0	120,0	60,0	4,0			11,060	86233671	86236671	86433671	86436671
120 x 80 x 3,0	120,0	80,0	3,0			9,525	86233685	86236685	86433685	86436685
120 x 80 x 4,0	120,0	80,0	4,0			12,600	86233687	86236687	86433687	86436687
150 x 50 x 3,0	150,0	50,0	3,0			9,525	86233751	86236751	86433751	86436751
150 x 50 x 5,0	150,0	50,0	5,0			15,270	86233755	86236755	86433755	86436755
150 x 100 x 4,0	150,0	100,0	4,0			15,624	86233765	86236765	86433765	86436765
150 x 100 x 5,0	150,0	100,0	5,0			19,404	86233767	86236767	86433767	86436767
160 x 80 x 3,0	160,0	80,0	3,0			11,180	86233777	86236777	86433777	86436777
200 x 100 x 5,0	200,0	100,0	5,0			23,040	86233837	86236837	86433837	86436837