



KIESELMANN
FLUID PROCESS GROUP

Translation of the original

Operating instruction

Sample valves Type 6001 - 6010



PDF • ak • 24/10/2019

KIESELMANN GmbH

Paul-Kieselmann-Str. 4-10
75438 Knittlingen

 +49(0) 7043 371-0 •  +49(0) 7043 371-125
www.kieselmann.de • info@kieselmann.de

Copyright: © KIESELMANN FLUID PROCESS GROUP

Table of contents

1	General informations	4
1.1	Informations for your safety	4
1.2	Marking of security instructions	4
1.3	General designated use	4
1.4	Personnel	4
1.5	Modifications, spare parts, accessories	5
1.6	General instructions	5
2	Safety instructions	6
2.1	Intended use	6
2.2	General notes	6
2.3	General safety instructions	6
3	Delivery, transport and storage	7
3.1	Delivery	7
3.2	Transport	7
3.3	Storage	7
4	Function and operation	8
4.1	Description of function	8
4.2	Commissioning, service and maintenance	8
4.2.1	Commissioning	8
4.2.2	Service	8
4.2.3	Cleaning	9
4.2.4	Sterilization	9
5	Technical data	10
6	Disassembly and assembly	11
6.1	Removal of the seals	11
7	Drawings and dimensions	12
7.1	Drawings	12
7.2	Dimensions	13
8	Wearing parts	14
9	Appendix	15
9.1	Declaration of incorporation	15

1 General informations

1.1 Informations for your safety

We are pleased that you have decided for a high-class KIESELMANN GmbH product. With correct application and adequate maintenance, our products provide long time and reliable operation.





Before installation and initiation, please carefully read this instruction manual and the security advices contained in it. This guarantees reliable and safe operation of this product and your plant respectively. Please note that an incorrect application of the process components may lead to great material damages and personal injury.

In case of damages caused by non observance of this instruction manual, incorrect initiation, handling or external interference, guarantee and warranty will lapse!

Our products are produced, mounted and tested with high diligence. However, if there is still a reason for complaint, we will naturally try to give you entire satisfaction within the scope of our warranty. We will be at your disposal also after expiration of the warranty. In addition, you will also find all necessary instructions and spare part data for maintenance in this instruction manual. If you don't want to carry out the maintenance by yourself, our KIESELMANN GmbH - service team will naturally be at your disposal.

1.2 Marking of security instructions

Hints are available in the chapter "safety instructions" or directly before the respective operation instruction. The hints are highlighted with a danger symbol and a signal word. Texts beside these symbols have to be read and adhered to by all means. Please continue with the text and with the handling at the valve only afterwards.

Symbol	Signal word	Meaning
	DANGER	Imminent danger which will result severe personal injury or death.
	WARNING	Imminent danger which may result severe personal injury or death.
	CAUTION	Dangerous situation which may cause slight personal injury or material damages.
	NOTICE	An harmful situation which may result in damages of the product itself or of adjacent vicinity.
	INFORMATION	Marks application hints and other information which is particularly useful.

1.3 General designated use

The fitting is designed exclusively for the purposes described below. Using the fitting for purposes other than those mentioned is considered contrary to its designated use. KIESELMANN GmbH cannot be held liable for any damage resulting from such use. The risk of such misuse lies entirely with the user. The prerequisite for the reliable and safe operation of the fitting is proper transportation and storage as well as competent installation and assembly. Operating the fitting within the limits of its designated use also involves observing the operating, inspection and maintenance instructions.

1.4 Personnel

Personnel entrusted with the operation and maintenance of the tank safety system must have the suitable qualification to carry out their tasks. They must be informed about possible dangers and must understand and observe the safety instructions given in the relevant manual. Only allow qualified personnel to make electrical connections.

1.5 Modifications, spare parts, accessories

Unauthorized modifications, additions or conversions which affect the safety of the fitting are not permitted. Safety devices must not be bypassed, removed or made inactive. Only use original spare parts and accessories recommended by the manufacturer.

1.6 General instructions

The user is obliged to operate the fitting only when it is in good working order. In addition to the instructions given in the operating manual, please observe the relevant accident prevention regulations, generally accepted safety regulations, regulations effective in the country of installation, working and safety instructions effective in the user's plant.

2 Safety instructions

2.1 Intended use

The sample valve is used to remove or vent liquid or gaseous media from tanks or pipe system in plants of the food and drink industry, pharmaceutical and chemical industries as well as in biotechnology.

2.2 General notes



NOTICE - observe the operating instructions

To avoid danger and damage, the fitting must be used in accordance with the safety instructions and technical data contained in the operating instructions.



NOTICE

All data are in line with the current state of development. Subject to change as a result of technical progress.

2.3 General safety instructions



WARNING

Risk of injury by outflowing medium

Dismantling the valve or valve assemblies from the plant can cause injuries.

- Medias flowing through the leakage drain outlet are to be drained off without splashing into a discharge arrangement.
- Carry the disassembling only if when the plant has been rendered pressure-less and free of liquid and gas.



CAUTION

Risk of burning whilst flaming the valve!

There is a risk from burns of parts of the body.

- The valve gets very hot under flaming. When flaming the valve,
 - wear suitable protective gloves and protective clothing
 - local fire safety regulations must be followed.



CAUTION

Destroy of the valve seal when flaming the valve!

The valve seal can be destroyed by excessive heat supply.

- The valve must be flamed generally by trained personnel.
 - The instructions in the chapter "Sterilization" must be observed.

3 Delivery, transport and storage

3.1 Delivery

- Immediately after receipt check the delivery for completeness and transport damages.
- Remove the packaging from the product.
- Retain packaging material, or expose of according to local regulations.

3.2 Transport



CAUTION

Risk of injury and damage to the product

During the transport the generally acknowledged rules of technology, the national accident prevention regulations and company internal work and safety regulations must be observed.

3.3 Storage



NOTICE

Damage to the product due to improper storage!

Observe storage instructions

avoid a prolonged storage



INFORMATION

Recommendation for longer storage

We recommend regularly checking the product and the prevailing storage conditions during long storage times.

- To avoid damage to seals and bearings,
 - products up to DN 125 / OD 5 inch should be stored horizontally for maximum 6 months.
 - products larger than DN 125 / 5 inch, should be stored in the upright position with the actuator on top.
- Don't store any objects on the products.
- Protect the products for wetness, dust and dirt.
- The product should be stored in a dry and well ventilated room at a constant temperature (optimal indoor temperature: 25 C ±5 ; indoor humidity data 70% ±5%).
- Protect seals, bearings and plastic parts for UV light and ozone.

4 Function and operation

4.1 Description of function

The valve is manually opened by turning it anti-clockwise and closed by turning it clockwise. At open valve, the product flows out through the outlet pipe (B).

4.2 Commissioning, service and maintenance

4.2.1 Commissioning

4.2.1.1 Installation instructions

Fitting position

Install the connection lines in such a way as to permit the liquids to drain freely out of the drain outlet (B).

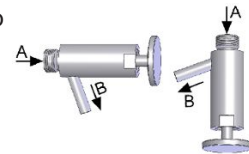

4.2.1.2 General welding guidelines

Sealing elements integrated in weld components must generally be removed prior to welding. To prevent damage, welding should be undertaken by certified personnel (EN ISO 9606-1). Use the TIG (Tungsten Inert Gas) welding process.



CAUTION

Damage and injuries due to high temperature supply

To avoid a distortion of the components, all welding parts must be welded to stress-relieved. Allow all components to cool before assembling.



NOTICE

Damage due to impurities

Impurities can cause damage to the seals and seals area. Clean inside areas prior to assembly.

4.2.1.3 ATEX - Guidelines

For valves or plants/installations that are operated in the ATEX area, sufficient bonding (grounding) must be ensured (see valid ATEX Guidelines EG).

4.2.2 Service



RECOMMENDATION

Replacement of seals

To achieve optimal maintenance cycles, the following points must be observed!

- When replacement of seals, all product-contacting seals should be replaced.
- Only original spare parts may be installed.

Maintenance interval

The maintenance intervals depend on the operating conditions "temperature, temperature-intervals, medium, cleaning medium, pressure and opening frequency". We recommend replacing the seals 1-year cycle. The user, however, should establish appropriate maintenance intervals according to the condition of the seals.

Lubricant recommendation

	EPDM; HNBR; NBR; FKM; k-flex	- Klüber Paraliq GTE703*
	Silicone	- Klüber Sintheso pro AA2*
	Thread	- Interflon Food*
*) It is only permitted to use approved lubricants, if the respective fitting is used for the production of food or drink. Please observe the relevant safety data sheets of the manufacturers of lubricants.		

4.2.3 Cleaning

The cleaning of the valve occurs in the closed state over connection (B), whereat with concurrent cleaning of the tank or pipe system the valve can be opened.

4.2.4 Sterilization

The valve can be sterilized with flame, steam or liquid.

Steam - and liquid sterilization

The steam or liquid sterilization proceeds through the outlet pipe (B) or during tank or pipe cleaning.

Air sterilization by flaming

The valve can be sterilized by flaming. This process may take up to 15 seconds for the entire valve. To avoid high temperatures at certain points the flame has to be moved constantly.

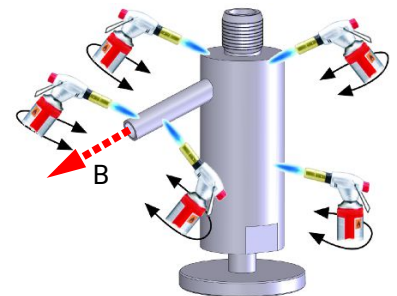

⚠ CAUTION

Risk of burning whilst flaming the valve!

There is a risk from burns of parts of the body.

- The valve gets very hot under flaming. When flaming the valve,
 - wear suitable protective gloves and protective clothing
 - local fire safety regulations must be followed.



⚠ CAUTION

Destroy of sealing materials due to high heat supply!

When flaming attention must be paid so that the valve is not exposed to short-time temperature exceeding 130°C, otherwise the sealing material will be destroyed.

- The valve must be flamed generally by trained personnel.

5 Technical data

Model	Sample valve
	• manual
Valve size	DN6 - DN20
Connection	<ul style="list-style-type: none"> • Whitworth pipe thread DIN ISO 228 • Liner / nut DIN 11581
Operating pressure	10 bar
Temperature range	<p>Operating temperature: +0° to +95°C (medium dependent)</p> <p>Sterilization temperature: EPDM +140°C (SIP 30 min) PTFE +130°C NBR +130°C</p>
Material: (in product contact)	<p>stainless steel: 1.4301 / AISI 304 1.4404 / AISI 316L</p> <p>Surface: Ra ≤ 0,8µm e-polished</p> <p>Sealing material: <ul style="list-style-type: none"> • EPDM • PTFE • VMQ </p>

6 Disassembly and assembly

6.1 Removal of the seals

Disassembly

- Remove the circlip (4) with a circlip pliers.
- Unscrew the valve spindle (3) out of the housing (5).
- Remove the cap (1) and the O-ring (2).

Assembly

- Before installation, thoroughly clean and slightly lubricate mounting areas and running surfaces.
- Lightly grease and mounting the O-ring (2).
- Lock the cap (1) on positive-locking profile of the valve spindle (3).
- Grease slightly over the thread of the spindle (3) and screw in.
- Install the circlip (4) with tailoring below.
- Check the function according to the specified performance data in the operating state.

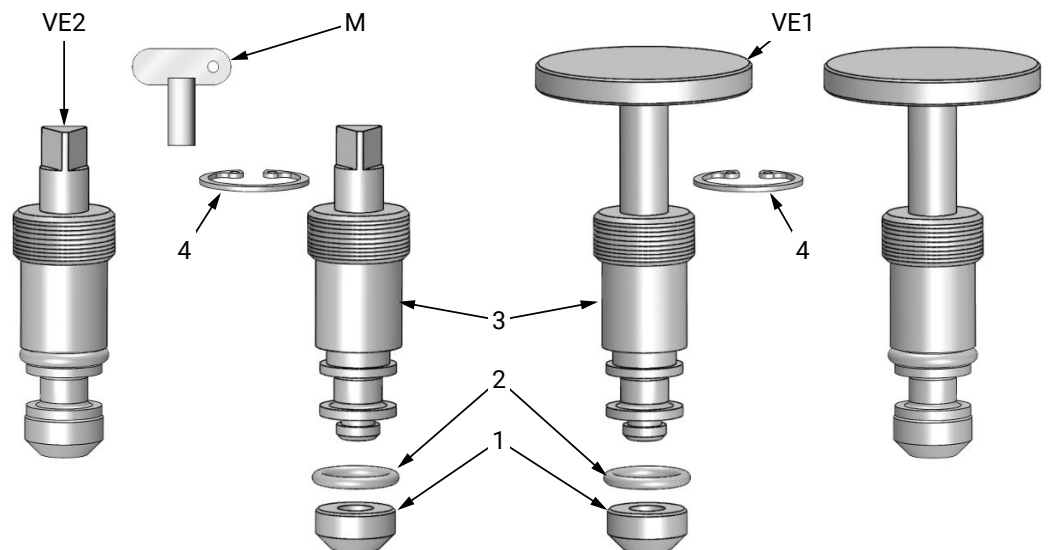

1 Cap	2 O-ring
3 Spindle	4 Circlip ring
VE1 Valve insert 1 with handwheel	VE2 Valve insert 2 with triangle
M triangular wrench	

7 Drawings and dimensions

7.1 Drawings

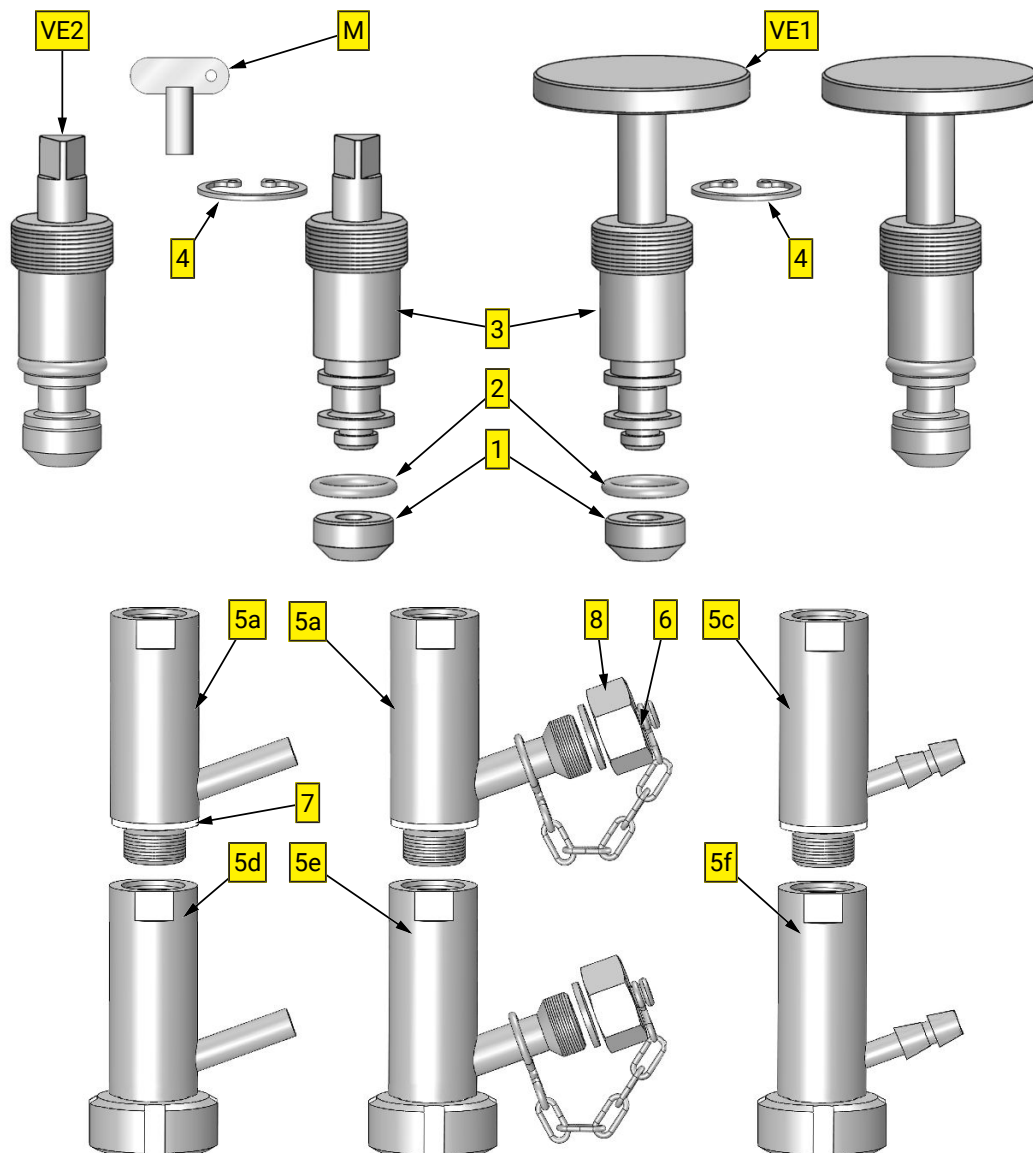

1 Cap	2 O-ring
3 Spindle	4 Circlip ring
5a Housing outlet pipe blank	5b Housing - outlet pipe with thread and blind cap
5c Housing outlet pipe with hose nozzle	5d Housing outlet pipe blank
5e Housing - outlet pipe with thread and blind cap	5f Housing outlet pipe with hose nozzle
6 Blind cap	7 Seal
8 Seal for blind cap	M triangular wrench
VE1 Valve insert 1 with handwheel	VE2 Valve insert 2 with triangle

7.2 Dimensions

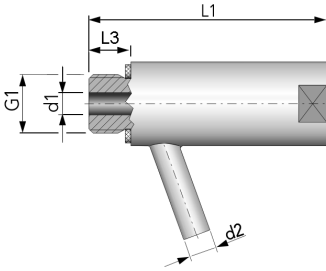
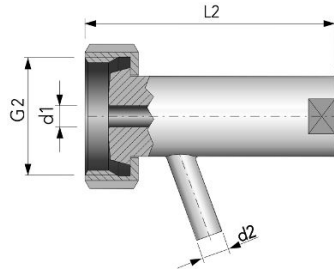
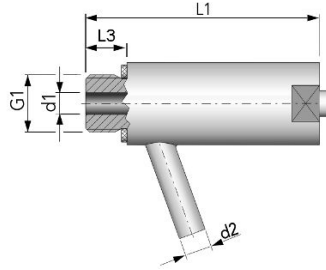
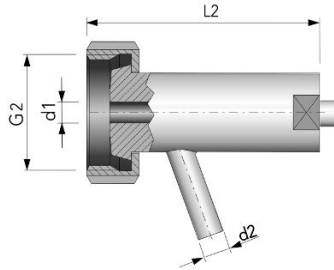
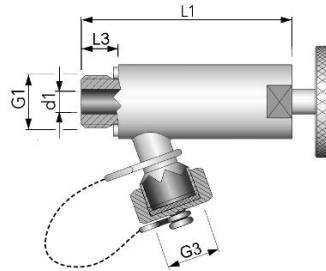
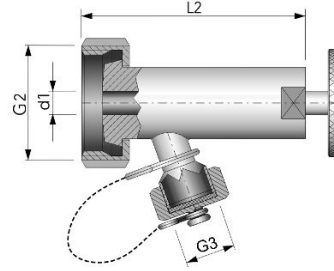
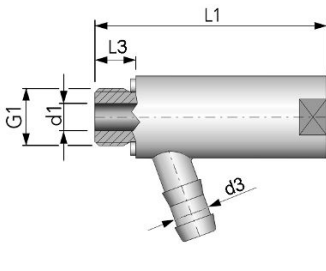
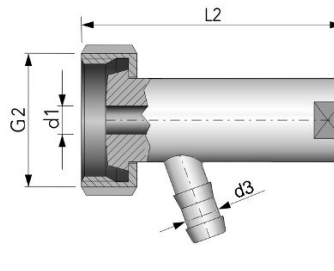
		Type 6001 - Inside Triangular	Type 6002 - Inside Triangular
Type 6001:	Inside Triangular, threaded connection outlet = outlet pipe		
Type 6002:	Inside Triangular, Liner/nut connection outlet = outlet pipe		
		Type 6001 - Handwheel	Type 6002 - Handwheel
Type 6001:	Handwheel, threaded connection outlet = outlet pipe		
Type 6002:	Handwheel, Liner/nut connection outlet = outlet pipe		
		Type 6007	Type 6008
Type 6007:	Handwheel, threaded connection outlet = threaded connection with blind cap		
Type 6008:	Handwheel, Liner/nut connection outlet = threaded connection with blind cap		
		Type 6009	Type 6010
Type 6009:	Handwheel, threaded connection outlet = hose nozzle		
Type 6010:	Handwheel, Liner/nut connection outlet = hose nozzle		

DN	d1	d2	d3	L1	L2	L3	G1	G2	G3
6	6	10x1	8	82	82	12	G3/8	Rd44x1/6	G3/8
8	8		-	85	85	15	G1/2	Rd44x1/6	G1/2
10	10		13	85	85	15	G1/2	Rd44x1/6	G1/2
15	14	-	19	85	85	15	G1/2	Rd44x1/6	G1/2
20	18	-	25	100	100	15	G3/4	Rd44x1/6	G3/4

8 Wearing parts

Pos.	Designation	Material	DN 6	DN 8	DN 10	DN 15	DN 20
1	Cap	PTFE	2329 017 085-053				2329 022 100-053
2	O-ring	NBR EPDM	2304 012 030-055 2304 012 030-170				2304 015 035-055 2304 015 035-054
4	Circlip ring	AISI304L	8085 022 100-020				8085 027 120-020
7	Seal	NBR EPDM	2353 024 015-077 -	2353 028 018-077 2353 028 018-054		2353 033 024-077 2353 033 024-054	
8	seal disc for blind cap	NBR EPDM	2319 016 020-067 2319 016 020-054	2319 021 020-067 2319 021 020-054		2319 028 030-067 2319 028 030-054	
M	wrench with male triangular	AISI304L	6003 008 000-021			-	-

9 Appendix

9.1 Declaration of incorporation



Declaration of incorporation

Translation of the original

Manufacturer / authorised representative:

KIESELMANN GmbH
Paul-Kieselmann-Str. 4-10
75438 Knittlingen
Germany

Authorised representative:
(for compiling technical documents)

Achim Kauselmann
Paul-Kieselmann-Str. 4-10
75438 Knittlingen
Germany

<u>Product name</u>	<u>Function</u>
pneum. Lift actuators	Stroke movement
pneum. Rotary actuators	Rotary movement
Ball valves	Media cutoff
Butterfly valves	Media cutoff
Single seat valves	Media cutoff
Flow control valves	Control of liquefied media
Throttle valve	Control of liquefied media
Overflow valve	Definition of fluid pressure
Double seat valve	Media separation
Bellow valves	Sampling of liquids
Sampling valves	Sampling of liquids
Two way valves	Media cutoff
Tankdome fitting	Prevention of overpressure and vacuum, Tank cleaning
Safety valve	Prevention of overpressure

The manufacturer hereby states that the above product is considered as an incomplete machine in the sense defined in the Directive 2006/42/EC on Machinery. The above product is exclusively intended to be installed into a machine or an incomplete machine. The said product does not yet conform to all the relevant requirements defined in the Directive on Machinery referred to above for this reason.

The specific technical documents listed in Appendix VII, Part B, have been prepared. The Authorized Agent empowered to compile technical documents may submit the relevant documents if such a request has been properly justified.

Commissioning of an incomplete machine must not only be carried out if it has been determined that the respective machine into which the incomplete machine is to be installed conforms to the regulations set out in the Directive on Machinery referred to above.

The above product conforms to the requirements of the directives and harmonized standards specified below:

- Directive 2014/68/EU
- DIN EN ISO 12100 Safety of machinery

Knittlingen, 21.07.2017

i.V. Uwe Heisswulf
Head of Development