



I Application

The INNOVA M-type valve is a pneumatic shut-off seat valve for hygienic applications.

The valve is designed for the direction of product flow from the upper to the lower body.

To avoid the effect of water hammer, the valve closes against the flow.

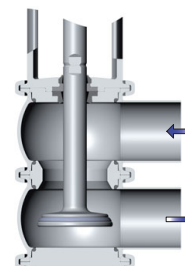

I Design and features

Gasket with specific profile guarantees reliability under adverse working conditions.

Hygienic design of the gasket ensures optimal cleaning.

Single-acting pneumatic actuator.

Normally closed valve (NC).

The valve can be changed to normally open (NO) by simply reversing the position of the pneumatic actuator.

Easy assembly/disassembly of internal parts by loosening a clamp fastener.

Open lantern allows visual inspection of shaft sealing.

360° adjustable body.

I Technical specifications

Materials:

Parts in contact with the product	AISI 316L (1.4404)
Other stainless steel parts	AISI 304 (1.4301)
Gasket	EPDM according to FDA 177.2600

Surface finish:

Internal	Bright polish Ra ≤ 0,8 µm
External	Matt

Available sizes:

DIN 11850	DN 25 - DN 100
ASME BPE	OD 1" - OD 4"

Connections:

Weld

Operating limits:

Temperature range (EPDM)	-10 °C to +121 °C	14 °F to 250 °F
Temperature SIP, max. 30 min	+140 °C	284 °F
Maximum working pressure	10 bar	145 PSI
Minimum working pressure	Vacuum	Vacuum
Compressed air pressure	6-8 bar	87-116 PSI
Air connections	G 1/8 (BSP)	G 1/8 (BSP)

I Options

Double-acting pneumatic actuator.

Gaskets: FPM, HNBR.

Other connection types.

Control unit: C-TOP and C-TOP+.

External position sensors.

Surface finish: Ra ≤ 0,5 µm.



I Housing combinations

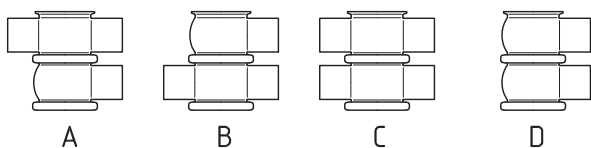

I Dimensions

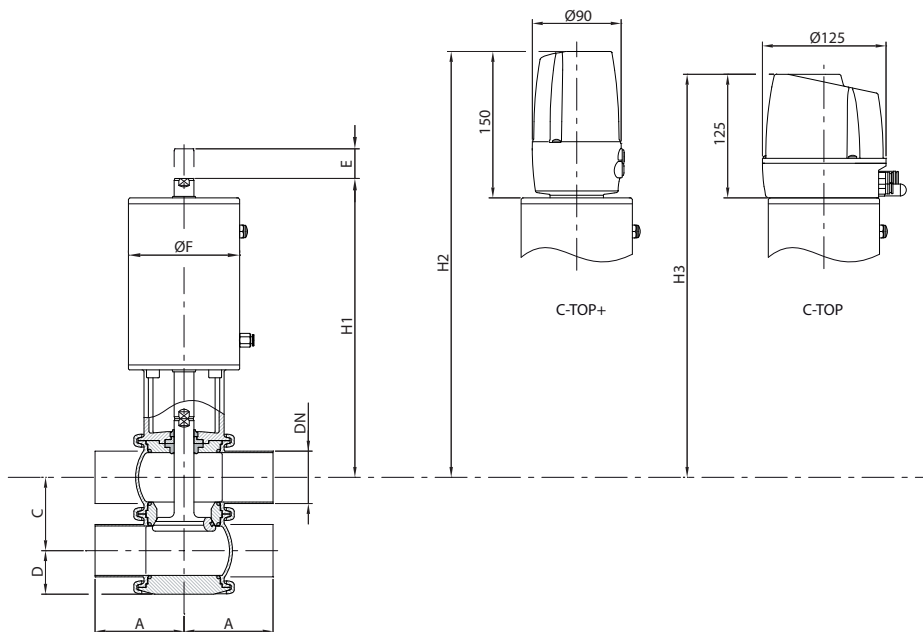

	DN	Pipe ϕ	A	C	D	ϕF	E	H ₁	H ₂	H ₃	kg
DIN	25	29 x 1,5	50	50	32	87	11	228	367	342	5,7
	40	41 x 1,5	85	62	38	87	21	238	377	352	7,0
	50	53 x 1,5	90	74	44	112	28	300	433	408	11
	65	70 x 2,0	110	92	53	143	31	346	485	460	20
	80	85 x 2,0	125	107	60	143	29	353	492	467	22
	100	104 x 2,0	150	127	70	216	31	381	516	491	39
OD	1"	25,4 x 1,65	50	46	30	87	15	226	369	344	5,7
	1½"	38,1 x 1,65	85	59	36	87	24	237	379	354	7,0
	2"	50,8 x 1,65	90	72	43	112	31	399	434	409	11
	2½"	63,5 x 1,65	110	86	50	143	37	343	488	463	20
	3"	76,2 x 1,65	125	99	56	143	37	349	496	471	22
	4"	101,6 x 2,11	150	124	69	216	33	379	517	492	39

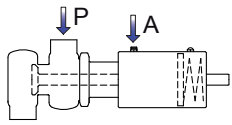
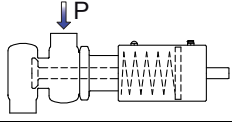
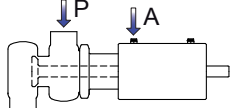

Maximum pressure in bar / PSI without leakage at the valve seat.

Actuator/valve body combination and direction of pressure	Air pressure	Plug position	OD 1" DN 25	OD 1½" DN 40	OD 2" DN 50	OD 2½" DN 65	OD 3" DN 80	OD 4" DN 100
	[bar] / [PSI]		[bar] / [PSI]					
	6 / 87	NO	10 / 145	7,4 / 107	4,5 / 65	5,6 / 81	4,7 / 68	10 / 145
	-	NC	10 / 145	6 / 87	6,1 / 89	6,3 / 91	5,3 / 77	5,6 / 81
	6 / 87	A/A	10 / 145	10 / 145	10 / 145	10 / 145	10 / 145	10 / 145

Maximum pressure in bar / PSI against which the valve can open.

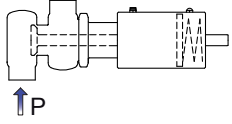
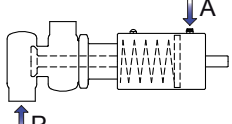
Actuator/valve body combination and direction of pressure	Air pressure	Plug position	OD 1" DN 25	OD 1½" DN 40	OD 2" DN 50	OD 2½" DN 65	OD 3" DN 80	OD 4" DN 100
	[bar] / [PSI]		[bar] / [PSI]					
	-	NO	10 / 145	7,9 / 115	10 / 145	9 / 131	7,6 / 110	7,7 / 111
	6 / 87	NC	10 / 145	9,1 / 132	9,7 / 141	8,4 / 121	7 / 102	10 / 145

A = Air
 P = Product pressure
 NC = Normally closed
 NO = Normally open
 A/A = Double acting

Note: Values for standard actuators.
 For other pressures, bigger actuators can be assembled.



FT-INNOVA-M.3.EN_0719