

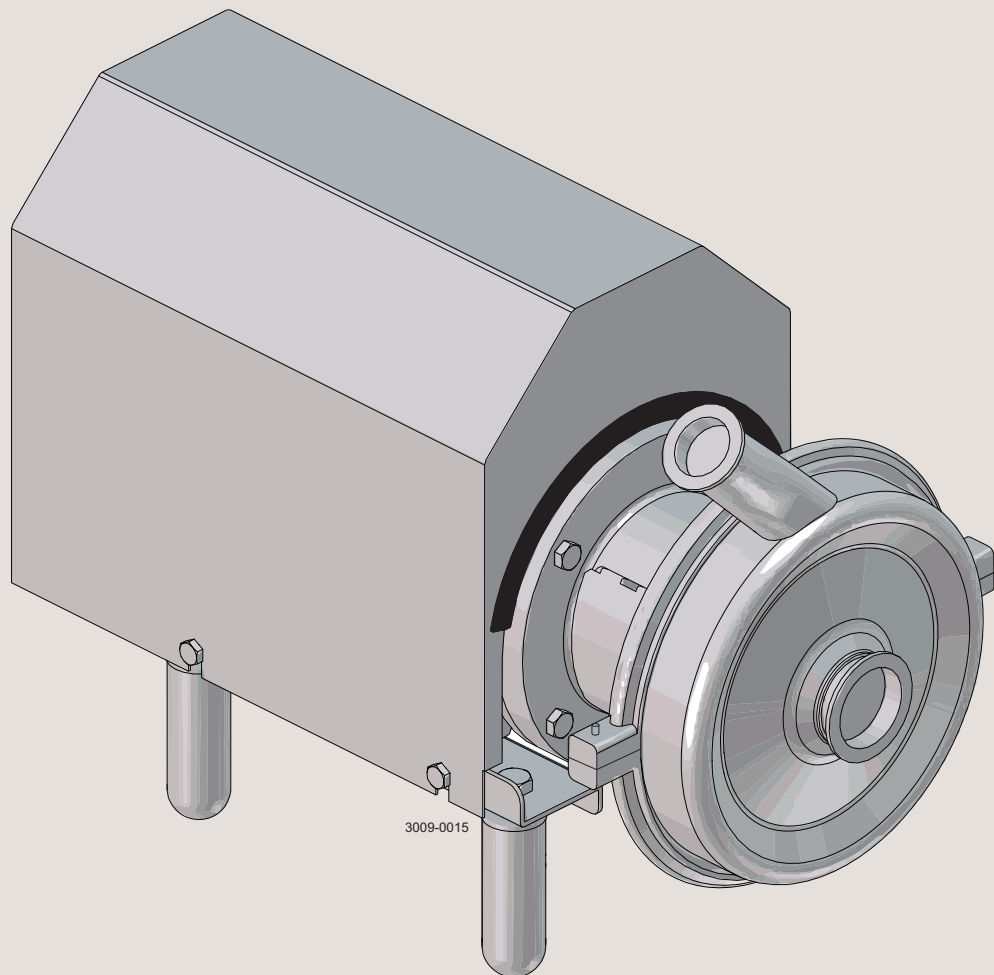

Instruction Manual

SolidC UltraPure



ESE00680-EN7

2018-02

Original manual



www.sk-online.com

The information herein is correct at the time of issue but may be subject to change without prior notice

1. EC Declaration of Conformity	4
2. Safety	5
2.1. Important information	5
2.2. Warning signs	5
2.3. Safety precautions	6
3. Installation	7
3.1. Unpacking/delivery	7
3.2. Installation	8
3.3. Pre-use check	9
3.4. Recycling information	9
4. Operation	10
4.1. Operation/control	10
4.2. Trouble shooting	11
4.3. Recommended cleaning	12
5. Maintenance	13
5.1. General maintenance	13
5.2. Cleaning procedure	14
5.3. Dismantling of pump/shaft seals	15
5.4. Assembly of pump/single shaft seal	17
5.5. Assembly of pump/flushed shaft seal	19
5.6. Adjustment of shaft	21
6. Technical data	22
6.1. Technical data	22
6.2. Relubrication intervals	23
6.3. Torque specifications	23
6.4. Weight (kg)	23
6.5. Noise emission	24
7. Parts list and service kits	25
7.1. Drawing	25
7.2. SolidC UltraPure - Wet end	26
7.3. SolidC UltraPure - Motor dependent parts	28
7.4. SolidC UltraPure - Shaft seal	30

1 EC Declaration of Conformity

Revision of Declaration of Conformity 2009-12-29

The Designated Company

Alfa Laval Kolding A/S

Company Name

Albuen 31, DK-6000 Kolding, Denmark

Address

+45 79 32 22 00

Phone No.

hereby declare that

Pump

Designation

SolidC UP-1, SolidC UP-2, SolidC UP-3, SolidC UP-4

Type

From serial number 10.000 to 1.000.000

is in conformity with the following directive with amendments:

- Machinery Directive 2006/42/EC

The person authorised to compile the technical file is the signer of this document

Global Product Quality Manager
Pump, Valves, Fittings and Tank Equipment

Title

Lars Kruse Andersen

Name

Kolding
Place

2013-12-03
Date

Signature



*Unsafe practices and other important information are emphasised in this manual.
Warnings are emphasised by means of special signs.
Always read the manual before using the pump!*

2.1 Important information

WARNING

Indicates that special procedures must be followed to avoid serious personal injury.

CAUTION

Indicates that special procedures must be followed to avoid damage to the pump.

NOTE

Indicates important information to simplify or clarify procedures.

2.2 Warning signs

General warning:



Dangerous electrical voltage:



Caustic agents:



2 Safety

Unsafe practices and other important information are emphasised in this manual.

Warnings are emphasised by means of special signs.

Always read the manual before using the pump!

2.3 Safety precautions

Installation:

Always read the technical data thoroughly. (See chapter 6 Technical data)

Always use a lifting crane when handling the pump.

Never start in the wrong direction of rotation with liquid in the pump.



Always have the pump electrically connected by authorised personnel.



Operation:

Always read the technical data thoroughly. (See chapter 6 Technical data)

Never touch the pump or the pipelines when pumping hot liquids or when sterilising.

Never run the pump with both the suction side and the pressure side blocked.

Never run the pump when partially installed or not completely assembled.

Necessary precautions must be taken if leakage occurs as this can lead to hazardous situations.



Always handle lye and acid with great care.

Never use the pump for products not mentioned in the Alfa Laval pump selection program.

The Alfa Laval pump selection program can be acquired from your local Alfa Laval sales company.



Maintenance:

Always read the technical data thoroughly. (See chapter 6 Technical data)

Never service the pump when it is hot.

Never service the pump if pressurised.

Always use Alfa Laval genuine spare parts.



Motors with grease nipples:

Remember lubrication according to information plate/label on the motor.

Always disconnect the power supply when servicing the pump.



Transportation:

Transportation of the pump or the pump unit:

Never lift or elevate in any way other than described in this manual

Always drain the pump head and accessories of any liquid

Always ensure that no leakage of lubricants can occur

Always transport the pump in its upright position

Always ensure that the unit is securely fixed during transportation

Always use original packaging or similar during transportation

3.1 Unpacking/delivery

Step 1

Always use a lifting crane when handling the pump (see technical data).

CAUTION

Alfa Laval cannot be held responsible for incorrect unpacking.

Check the delivery for

1. Complete pump.
2. Delivery note.
3. Motor instructions.
4. Test certificate, IF ORDERED!!

Step 2

Remove possible packing materials from the inlet, outlet and drain.
Avoid damaging the inlet and the outlet.
Avoid damaging the connections for flushing liquid, if supplied.

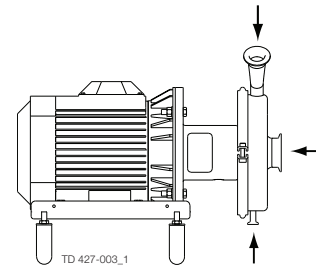

Step 3

Inspect the pump for visible transport damage.

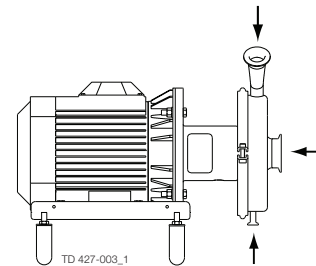

Step 4

Always remove the shroud, if fitted, before lifting the pump.

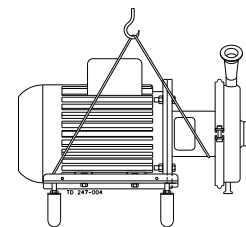

3 Installation

Study the instructions carefully and pay special attention to the warnings! Always check the pump before operation.

- See pre-use check in section 3.3

The large pump sizes are very heavy. Alfa Laval therefore recommends the use of a lifting crane when handling the pump.

3.2 Installation

Step 1



Always read the technical data carefully.

Always use of a lifting crane when handling the pump. (See technical data).

NOTE

In case of shaft seal leakage, the media will drip from the slot in the bottom of the adaptor. In case of shaft seal leakage, Alfa Laval recommends putting a drip tray underneath the slot to collect the leakage.



Always have the pump electrically connected by authorised personnel.
(see the motor instruction).

CAUTION

Alfa Laval cannot be held responsible for incorrect installation.

WARNING:

Alfa Laval recommends the installation of a lockable repair breaker. If the repair breaker is to be used as an emergency stop, the colours of the repair breaker must be red and yellow.

CAUTION

The pump does not prevent back flow when intentionally or unintentionally stopped. If back flow can cause any hazardous situations, precautions must be taken e.g. check valve to be installed in the system preventing above described.

Step 2

Ensure that there is sufficient clearance around the pump (min. 0.5 m) (1.64 ft).

NOTE!

US pumps have no shroud

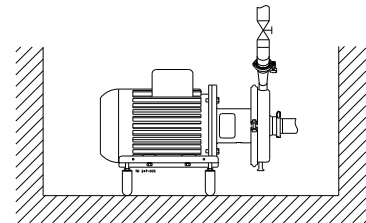

Step 3

Check that the flow direction is correct.

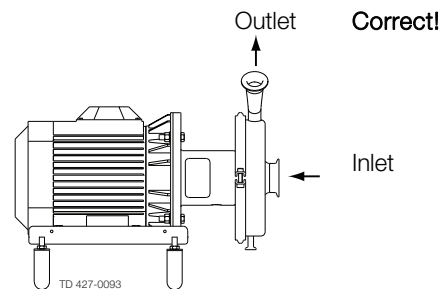

Step 4

1. Ensure that the pipelines are routed correctly.
2. Ensure that the connections are tight.

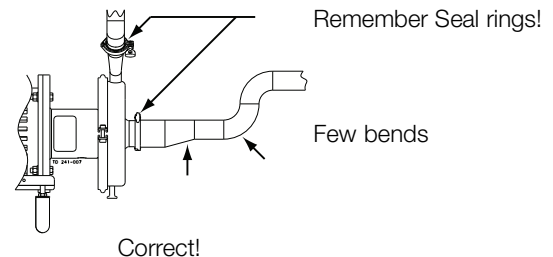

Step 5

Avoid stresses to the pump.

Pay special attention to:

- Vibrations
- Thermal expansion of the tubes
- Excessive welding
- Overloading

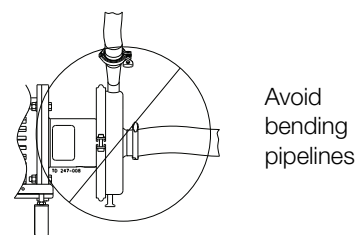

Study the instructions carefully and pay special attention to the warnings!
SolidC UltraPure comes with an impeller screw as standard.
Check the direction of rotation of the impeller before operation.
- See the indication label on the pump.

3.3 Pre-use check

Step 1



Never start in the wrong direction of rotation with liquid in the pump.

1. Start and stop the motor momentarily.
2. Ensure that the direction of rotation of the motor fan is clockwise as viewed from the rear end of the motor.

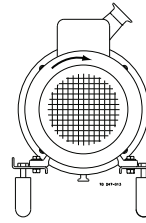

See indication label!

Correct

Rear view of motor

3.4 Recycling information

• Unpacking

- Packing material consists of wood, plastics, cardboard boxes and in some cases metal straps
- Wood and cardboard boxes can be reused, recycled or used for energy recovery
- Plastics should be recycled or burnt at a licensed waste incineration plant
- Metal straps should be sent for material recycling

• Maintenance

- During maintenance, oil and wear parts in the machine are replaced
- All metal parts should be sent for material recycling
- Worn out or defective electronic parts should be sent to a licensed handler for material recycling
- Oil and all non-metal wear parts must be taken care of in agreement with local regulations

• Scrapping

- At end of use, the equipment must be recycled according to the relevant, local regulations. In addition to the equipment itself, any hazardous residues from the process liquid must be considered and dealt with in a proper manner. When in doubt, or in the absence of local regulations, please contact your local Alfa Laval sales company.

4 Operation

Study the instructions carefully and pay special attention to the warnings!

4.1 Operation/control

Step 1



Always read the technical data carefully.
See chapter 6 Technical data

CAUTION

Alfa Laval cannot be held responsible for incorrect operation/control.

Step 2



Never touch the pump or the pipelines when pumping hot liquids or when sterilising.

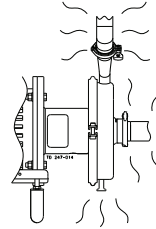

Danger of burns!



Step 3



Never run the pump with both the suction side and the pressure side blocked.

Danger of explosion!

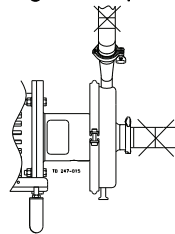

See the warning label!

Step 4

CAUTION

The shaft seal must not run dry.

CAUTION

Never throttle the inlet side.

Do not allow to run dry

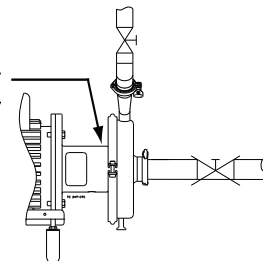

Correct!

Wrong

Step 5

Flushed shaft seal:

1. Connect the inlet of the flushing liquid correctly.
2. Regulate the water supply correctly.

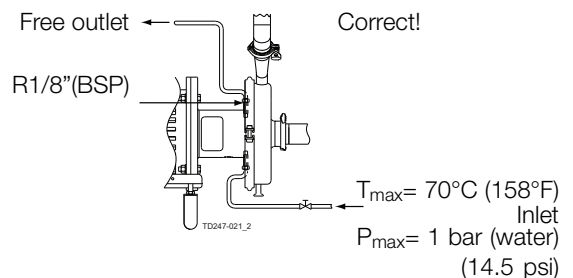

Correct!

Step 6

Control:

Reduce the capacity and the power consumption by means of:

- Throttling the pressure side of the pump.
- Reducing the impeller diameter.
- Reducing the speed of the motor.

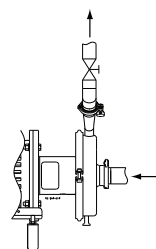

Throttling!

Pay attention to possible faults.
Study the instructions carefully.

4.2 Trouble shooting

NOTE!

Study the maintenance instructions carefully before replacing worn parts. - See section 5.1 General maintenance

Problem	Cause/result	Remedy
Overloaded motor	<ul style="list-style-type: none"> - Pumping of viscous liquids - Pumping of high density liquids - Low outlet pressure (counter pressure) - Lamination of precipitates from the liquid 	<ul style="list-style-type: none"> - Larger motor or smaller impeller - Higher counter pressure (throttling) - Frequent cleaning
Cavitation: <ul style="list-style-type: none"> - Damage - Pressure reduction (sometimes to zero) - Increasing of the noise level 	<ul style="list-style-type: none"> - Low inlet pressure - High liquid temperature 	<ul style="list-style-type: none"> - Increase the inlet pressure - Reduce the liquid temperature - Reduce the pressure drop before the pump - Reduce speed
Leaking shaft seal	<ul style="list-style-type: none"> - Dry run - Incorrect rubber grade - Abrasive particles in the liquid 	Replace: All wearing parts If necessary: <ul style="list-style-type: none"> - Change rubber grade - Select stationary and rotating seal ring in silicon carbide/silicon carbide
Leaking O-ring seals	Incorrect rubber grade	Change rubber grade

4 Operation

The pump is designed for cleaning in place (CIP). CIP = Cleaning In Place.
Study the instructions carefully and pay special attention to the warnings!
NaOH = Caustic Soda.
HNO₃ = Nitric acid.

4.3 Recommended cleaning

Step 1



Always handle lye and acid with great care.

Caustic danger!



Always use rubber gloves!



Always use protective goggles!

Step 2



Never touch the pump or the pipelines when sterilising.

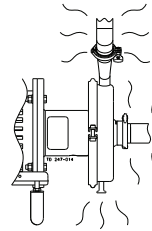

Danger of burns!



Step 3

Examples of cleaning agents: Use clean water, free from chlorides.

1. 1% by weight NaOH at 70°C (158°F).

1 kg (2.2 lb) NaOH + 100 l (26.4 gal) water = Cleaning agent.

2.2 l (0.6 gal) 33% NaOH + 100 l (26.4 gal) water = Cleaning agent.

2. 0.5% by weight HNO₃ at 70°C (158°F).

0.7 l (0.2 gal) 53% HNO₃ + 100 l (26.4 gal) water = Cleaning agent.

1. Avoid excessive concentration of the cleaning agent
⇒ Dose gradually!
2. Adjust the cleaning flow to the process.
Sterilisation of milk/viscous liquids
⇒ Increase the cleaning flow!

Step 4



Always rinse well with clean water after using a cleaning agent.

NOTE

The cleaning agents must be stored/disposed of in accordance with current regulations/directives.

Always rinse!

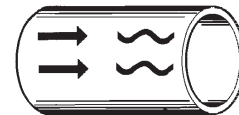

Clean water

Cleaning agent

Maintain the pump carefully. Study the instructions carefully and pay special attention to the warnings! Always keep spare shaft seals and rubber seals in stock.
See separate motor instructions.
Check the pump for smooth operation after service.

5.1 General maintenance

Step 1



Always read the technical data carefully.



Always disconnect the power supply when servicing the pump.

NOTE

All scrap must be stored/discharged in accordance with current rules/directives.

Step 2



Never service the pump when it is hot.

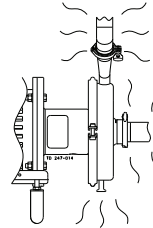

Danger of burns!



Step 3



Never service the pump with pump if pressurised.

CAUTION

Fit the electrical connections correctly if they have been removed from the motor during service.

CAUTION

Pay special attention to the warnings!

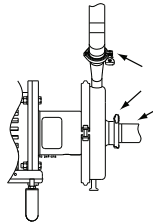

Atmospheric pressure required!

Step 4

Recommended spare parts:

Order Service kits from Service kits list (see chapter 7 Parts list and service kits).

Ordering spare parts

Contact your local Alfa Laval sales company.

NOTE

If the pump is supplied with FEP O-rings. Alfa Laval recommends the casing O-ring is replaced during pump maintenance.

5 Maintenance

Maintain the pump carefully. Study the instructions carefully and pay special attention to the warnings! Always keep spare shaft seals and rubber seals in stock.

See separate motor instructions.

Check the pump for smooth operation after service.

	Shaft seal	Rubber seals	Motor bearings
Preventive maintenance	Replace after 12 months: (one-shift) Complete shaft seal	Replace when replacing the shaft seal	
Maintenance after leakage (leakage normally starts slowly)	Replace at the end of the day: Complete shaft seal	Replace when replacing the shaft seal	
Planned maintenance	<ul style="list-style-type: none"> - Regular inspection for leakage and smooth operation - Keep a record of the pump - Use the statistics for inspection planning <p>Replace after leakage: Complete shaft seal</p>	Replace when replacing the shaft seal	Yearly inspection is recommended <ul style="list-style-type: none"> - Replace complete bearing if worn - Ensure that the bearing is axially locked (See motor instructions)
Lubrication	Before fitting Lubricate the O-rings with silicone grease or silicone oil	Before fitting Silicone grease or silicone oil	The bearings are permanently lubricated

Pre-use check

CAUTION!

Fit the electrical connections correctly if they have been removed from the motor during service.

(See pre-use check in section 3 Installation).

Pay special attention to warnings!

1. Start and stop the motor momentarily
2. Ensure that the pump operates smoothly.

5.2 Cleaning procedure

Cleaning procedure for soiled impeller screw tapped hole:

1. Remove stub shaft (7) as per section 4 of the Service manual.
2. Submerge and soak stub shaft for 5 minutes in COP tank with 2% caustic wash
3. Scrub the blind tapped impeller screw hole vigorously by plunging a clean 1/2" diameter sanitary bristle pipe brush in and out of the hole for two minutes while submerged.
4. Soak stub shaft (7) in acid sanitiser for 5 minutes, then scrub blind tapped hole as described in step 3 above.
5. Rinse well with clean water and blow-dry blind tapped hole with clean air.
6. Swab test the inside of the tapped hole to determine cleanliness.
7. Should the swab test fail, repeat steps 2 to 6 above until swab test is passed.

Should swab testing continue to fail, or time is of the essence, install a new (spare) stub shaft (7).

Study the instructions carefully. The items refer to the parts list and service kits section.

Handle scrap correctly.

* : Relates to the shaft seal.

5.3 Dismantling of pump/shaft seals

Step 1

Remove screws, spring washers, clamps (55) and pump casing (29).

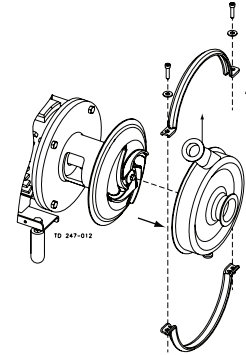

Step 2

Flushed shaft seal:

Unscrew tubes (42) using a spanner.

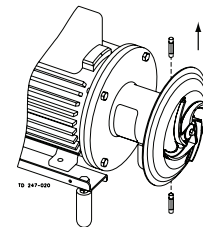

★

Step 3

Remove covers (22). This is easily done by lifting out the covers using a screwdriver for example.

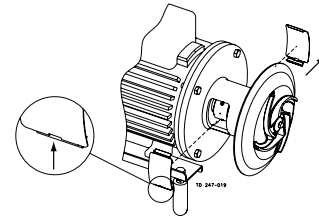

Step 4

1. Remove impeller screw (36).
2. Remove impeller (37). If necessary, loosen the impeller by tapping gently on the impeller vanes. The shaft can be fixed with a screwdriver in the compression ring.
3. Remove the O-ring (38) from the impeller.

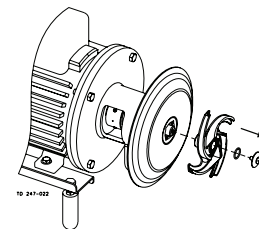

Step 5

1. Pull off the O-ring (26) from back plate (25).
2. Unscrew nuts (20) and remove washers (21) and the back plate.

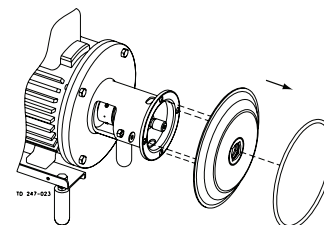

5 Maintenance

Study the instructions carefully. The items refer to the parts list and service kits section.

Handle scrap correctly.

* : Relates to the shaft seal.

Step 6

1. Remove the stationary seal ring (11).
2. Remove the O-ring (12) from stationary seal ring (11).

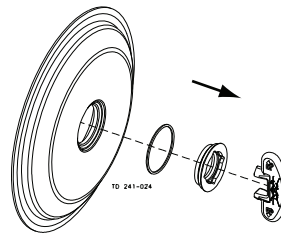

★
Use the tool supplied. Left hand thread

Step 7

Flushed shaft seal:

1. Remove screws (41) and seal housing (40).
2. Pull out lip seal (43) from the seal housing.

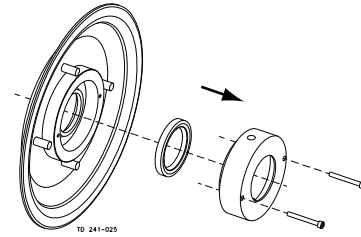

★

Step 8

1. Remove the complete shaft seal from stub shaft (7).
2. Remove spring (13) and rotating seal ring (14) from the drive ring (10).

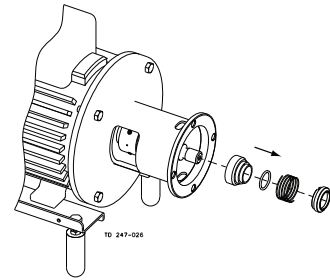

★

Alternative dismantling of single shaft seal - Front loading

1. Complete steps 1 through 4.
2. Remove stationary seal ring.
3. Remove O-ring (12) from stationary seal ring (11).
4. Remove complete shaft seal from stub shaft.
5. Remove spring (13) and rotating seal ring (14) from the drive ring (10).

Use the tool supplied. Left hand thread ★

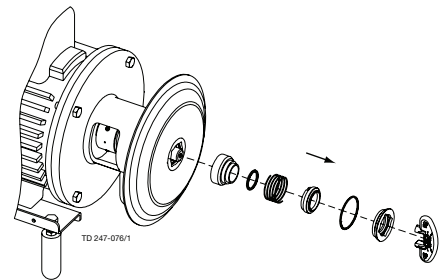

Study the instructions carefully. The items refer to the parts list and service kits section.

Handle scrap correctly.

* : Relates to the shaft seal.

5.4 Assembly of pump/single shaft seal

Step 1

1. Remove spring (13).
2. Lubricate O-ring (15) and fit it in rotating seal ring (14).

NOTE!

Make sure that O-ring (15) has max. clearance from the sealing surface.

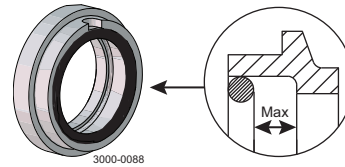

*

Step 2

1. Refit spring (13) on rotating seal ring (14).
2. Fit the spring and the rotating seal ring on drive ring (10).

CAUTION

Ensure that the driver on the drive ring enters the notch in the rotating seal ring.

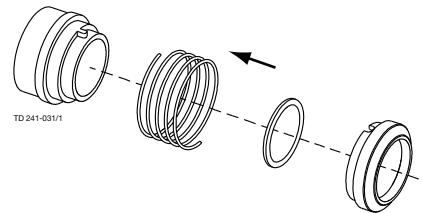

*

Step 3

Fit the complete shaft seal on stub shaft (7).

NOTE!

Make sure that connex pin on the stub shaft enters the notch in drive ring (10).

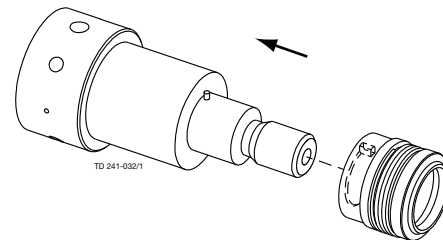

*

Step 4

1. Fit O-ring (12) on stationary seal ring (11) and lubricate.
2. Screw the stationary seal ring into back plate (25).

CAUTION

Only tighten by hand to avoid deforming the stationary seal ring. (Max 7Nm, 5 lbf-ft)

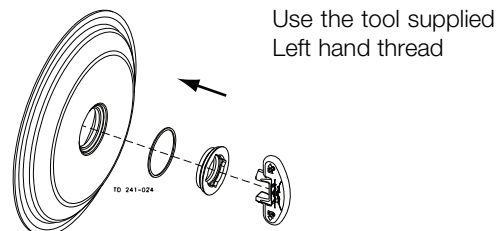

*

Step 5

1. Clean the sealing surfaces with contact cleaner before fitting back plate (25).
2. Carefully guide the back plate onto adaptor (16).
3. Fit washers (21) and nuts (22).

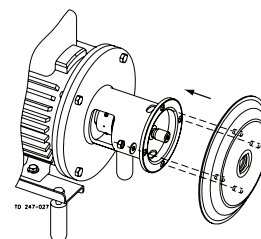

*

Step 6

Lubricate O-ring (26) and slide it onto back plate (25).

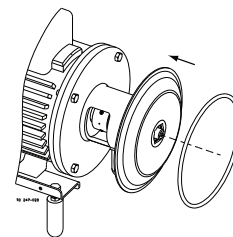

5 Maintenance

Study the instructions carefully. The items refer to the parts list and service kits section.

Handle scrap correctly.

* : Relates to the shaft seal.

Step 7

1. Lubricate O-ring (38) and fit it in impeller (37).
2. Lubricate the impeller hub with silicone grease or oil.
3. Screw the impeller onto stub shaft (7).
4. Fit impeller screw (39) and tighten 20Nm. (7.4 lbf-ft)

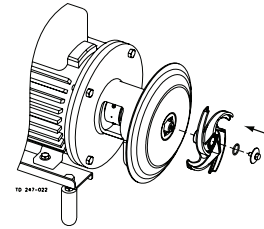

Step 8

Fit covers (22).

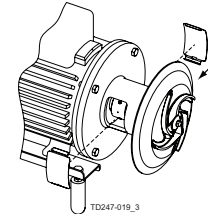

Step 9

Fit pump casing (29), clamps and spring washer and tighten screws (55).

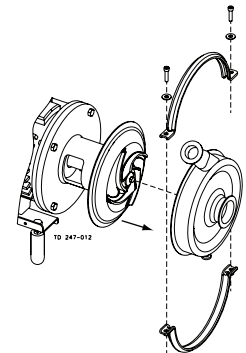

★

Alternative assembly of single shaft - front loading

1. Fit rotating seal ring (14) and spring (13) on drive ring (10).
2. Fit complete shaft seal on stub shaft.
3. Fit O-ring (12) onto stationary seal ring (11).
4. Fit stationary seal ring.
5. Complete steps 4 to 1.

CAUTION

Ensure that the driver on the drive ring enters the notch in the rotating seal ring.

Use the tool supplied
Left hand thread

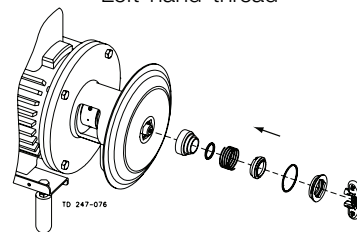

Study the instructions carefully. The items refer to the parts list and service kits section.
 Lubricate the rubber seals before fitting them.
 * : Relates to the shaft seal.

5.5 Assembly of pump/flushed shaft seal

Step 1

1. Fit O-ring (12) on stationary seal ring (11) and lubricate.
2. Screw the stationary seal ring into back plate (25).

CAUTION

Only tighten by hand to avoid deforming the stationary seal ring.
 (Max 7Nm, 5 lbf-ft)

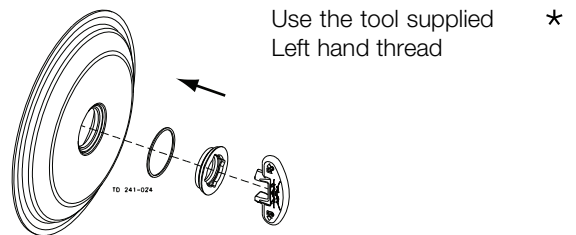

Step 2

Flushed shaft seal:

1. Fit lip seal (43) in seal housing (40).
2. Lubricate O-ring (44) and slide onto the seal housing (40).
3. Fit the seal housing on back plate (25) and tighten screws (41).

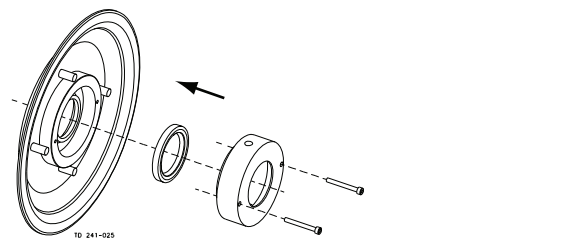

Step 3

1. Remove spring (13).
2. Lubricate O-ring (15) and fit it in rotating seal ring (14).

NOTE!

Make sure that O-ring (15) has max. clearance from the sealing surface.

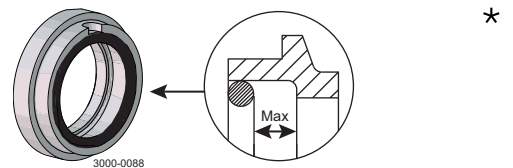

Step 4

1. Lubricate O-ring (45) and fit it in drive ring (10).
2. Fit spring (13) and rotating seal ring (14) on the drive ring.

CAUTION

Ensure that the driver on the drive ring enters the notch in the rotating seal ring.

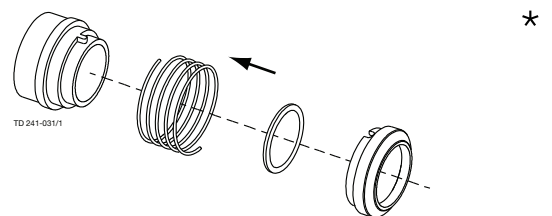

Step 5

Fit complete shaft seal on stub shaft (7) so that connex pin on the stub shaft enters the notch in drive ring (10).

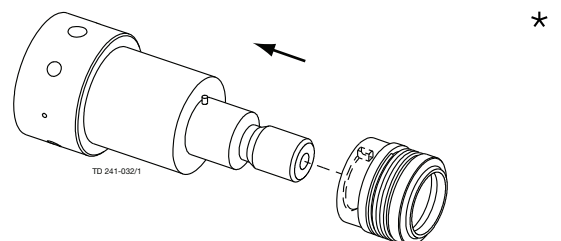

5 Maintenance

Study the instructions carefully. The items refer to the parts list and service kits section.

Lubricate the rubber seals before fitting them.

* : Relates to the shaft seal.

Step 6

1. Carefully guide back plate (25) onto adaptor (16).
2. Fit washers (21) and tighten nuts (20).

Note:

Make sure that holes in the seal housing are in a vertical position.

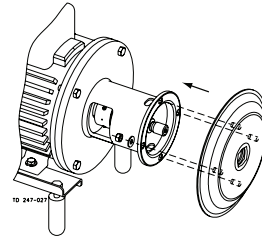

Step 7

Lubricate O-ring (26) and slide it onto back plate (25).

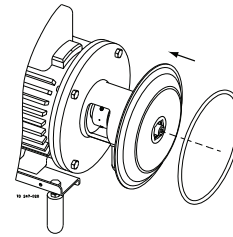

Step 8

1. Lubricate O-ring (38) and fit it in impeller (37).
2. Lubricate the impeller hub with silicone grease or oil.
3. Screw impeller (37) onto stub shaft (7).
4. Fit impeller screw (39) and tighten 20Nm. (7.4 lbf-ft)

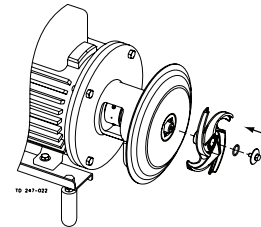

Step 9

1. Screw tubes (42) into seal housing (40).
2. Tighten with a spanner.

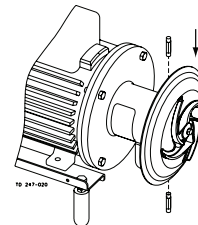

*

Step 10

Fit covers.

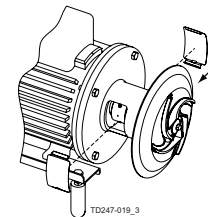

Step 11

Fit pump casing (29), clamps and spring washers and tighten screws (55).

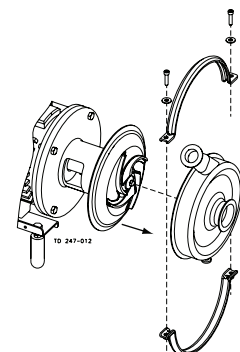

Study the instructions carefully. The items refer to the parts list and service kits section.
Lubricate the rubber seals before fitting them.
* : Relates to the shaft seal.

5.6 Adjustment of shaft

Step 1

1. Loosen screws (61).
2. Pull off stub shaft (7).

NOTE

Always use Alfa Laval Genuine Parts and ensure screws do not protrude from the shaft.

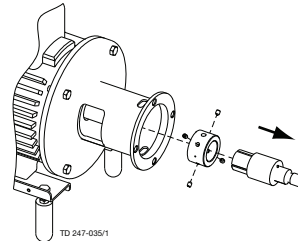

Step 2

1. Push stub shaft (7) onto the motor shaft.
2. Check that the clearance between the end of the stub shaft and the motor flange is 10-20 mm (0.4 - 0.8").

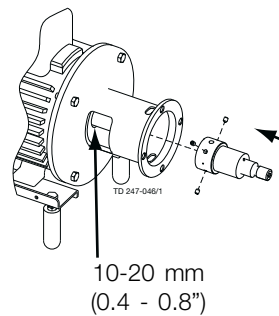

Step 3

1. Tighten screws (61) lightly and evenly.
2. Ensure that stub shaft (7) can be moved on the motor shaft.

Step 4

Fit back plate (25), washers (20) and nuts (21) and tighten.

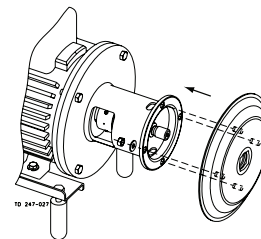

Step 5

1. Fit impeller (37) on stub shaft (7).
2. Ensure that the clearance between the impeller and back plate (25) is correct by using the tool supplied (1 mm (0.039")).

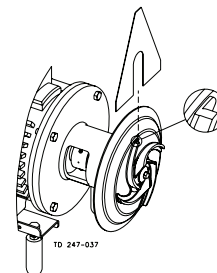

Step 6

Tighten screws (61) evenly to 18 Nm (13.3 lbf-ft).

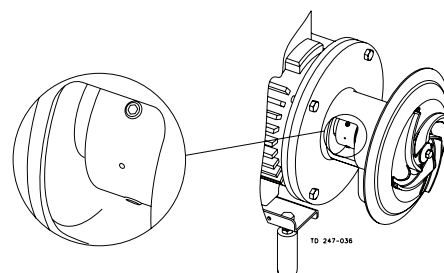

6 Technical data

*It is important to observe the technical data during installation, operation and maintenance.
Inform personnel about the technical data.*

6.1 Technical data

The SolidC UltraPure pump is an efficient and economical centrifugal pump, which meets the requirements of the pharmaceutical industries. It provides gentle product treatment and is chemically resistant. SolidC UltraPure is available in the following sizes, SolidC-1 UltraPure, SolidC-2 UltraPure, SolidC-3 UltraPure and SolidC-4 UltraPure. Study the instructions carefully. Standard delivery does not include the test certificate. This can be supplied on request.

Data	
Max. inlet pressure	400 kPa (4 bar) (58 psi)
Temperature range	-10°C to +120°C (14°F to 248°F) (EPDM)
Max. speed	4000 rpm
Materials	
Product wetted steel parts	AISI 316L
Other steel parts	Stainless steel
Finish	Semi-bright
Product wetted seals	EPDM USP Class VI
Other O-rings	EPDM USP Class VI
Alternative seals	Fluorinated rubber (FPM) and FEP.
Shaft seal	
Seal types	External single or flushed
Max. temperature flush media	70°C
Max. water pressure (flushed seal)	Normally atmospheric (max. 1 bar) (14.5 psi)
Water consumption (flushed seal)	0.25 - 0.5 l/min. (0.07 - 0.13 gpm)
Material, stationary seal ring (ROW)	Acid-resistant steel with sealing surface of silicon carbide
Material, rotating seal ring	Silicon carbide
Material, O-rings	EPDM USP Class VI
Alternative material, O-rings	Fluorinated rubber (FPM) and FEP
Motor	
Foot-flanged motor according to IEC metric standard 2 poles = 3000/3600 rpm. at 50/60 Hz IP55 (drain hole with labyrinth plug), insulation class F	
Motor sizes (Hp), 60 Hz	1.0 - 30 Hp
Motor sizes (kW), 50 Hz	1.1 - 22 kW
Motor sizes (kW), 60 Hz	1.3 - 25 kW
US: NEMA C-face Foot Mounted	
2 Poles = 3600 rpm at 60 Hz	
4 Poles = 1800 rpm at 60 Hz	

For further information see PD-sheet.

6 Technical data

*It is important to observe the technical data during installation, operation and maintenance.
Inform personnel about the technical data.*

6.2 Relubrication intervals

Motor bearings are permanently lubricated

6.3 Torque specifications

The table below specifies the tightening torques for the screws, bolts and nuts in this pump.
Always use torques below if no other values are stated. This can be a matter of personal safety.

Size	Tightening torque	
	Nm	lbf-ft
M8	20	14.8
M10	40	29.5
M12	67	49.0
M14	110	81.0

6.4 Weight (kg)

Pump Type: SolidC, SolidC UltraPure

Size	90		100	112	132		160		180	
	1.5kW	2.2kW	3kW	4kW	5.5kW	7.5kW	11kW	15kW	18.5kW	22kW
1	61	63	73	85						
2			76	87	108	120	173			
3					115	127	180	190	212	
4					117	129	179	189	211	267

Weight can vary depending of configuration. Weight is only to be seen as a reference value during handling, transporting and packaging.

6 Technical data

*It is important to observe the technical data during installation, operation and maintenance.
Inform personnel about the technical data.*

6.5 Noise emission

Pump type	Sound pressure level (dBA)
LKH-5	60
LKH-10	69
LKH-15	72
LKH-20	70
LKH-25	74
LKH-35	71
LKH-40	75
LKH-45	70
LKH-50	75
LKH-60	77
LKH-70	88
LKH-75	79
LKH-85	86
LKH-90	75
LKH-112	70
LKH-113	69
LKH-114	68
LKH-122	75
LKH-123	77
LKH-124	80
SolidC-1	68
SolidC-2	72
SolidC-3	73
SolidC-4	72
MR-166	76
MR-185	82
MR-200	81
MR-300	82
GM	54
FM-OS	61

The above LKH noise levels are the same for LKHDPF, LKHI, LKH UltraPure, LKH Evap and LKHHex.
The above SolidC noise levels are the same for SolidC UltraPure.

The noise measurements have been carried out with the original motor and shroud, at the approximate Best Efficiency Point (BEP) with water at ambient temperature and at 50 Hz.

Very often the noise level generated by the flow through the process system (e.g. valves, pipes, tanks etc.) is much higher than what is generated by the pump itself. Therefore, it is important to consider the noise level from the total system and take the necessary precautions with regards to personal safety, if required.

7 Parts list and service kits

The drawing shows SolidC UltraPure pump, sanitary version.
The items refer to the parts lists in the following sections

7.1 Drawing

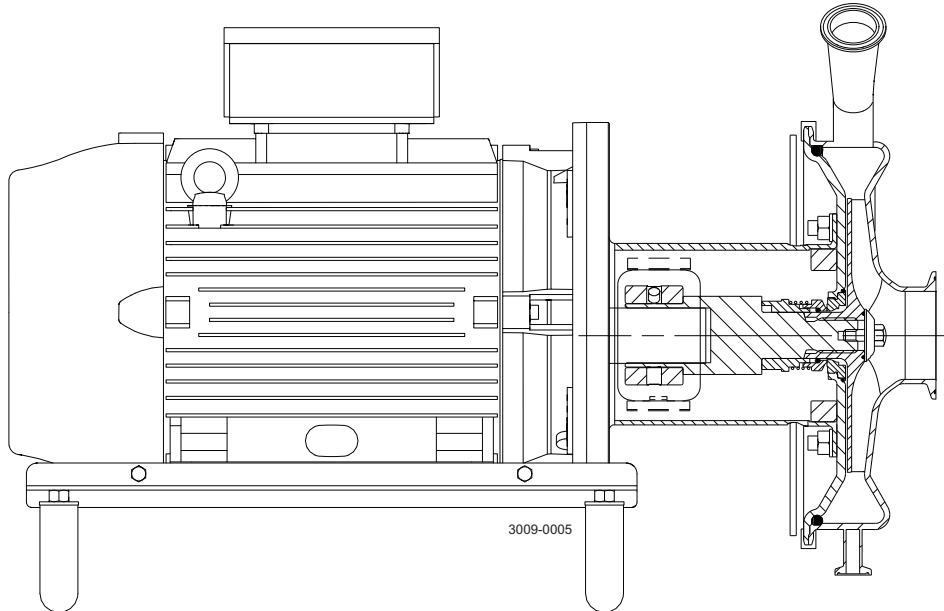

US legs are different to the ones shown. For further information see spare parts catalogue.

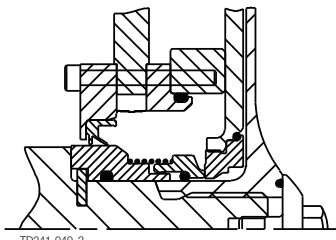

Flushed shaft seal

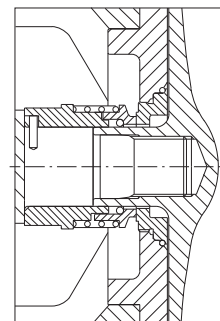

Single shaft seal

7 Parts list and service kits

The drawing shows SolidC UltraPure pump, sanitary version. The items refer to the parts lists in the following sections

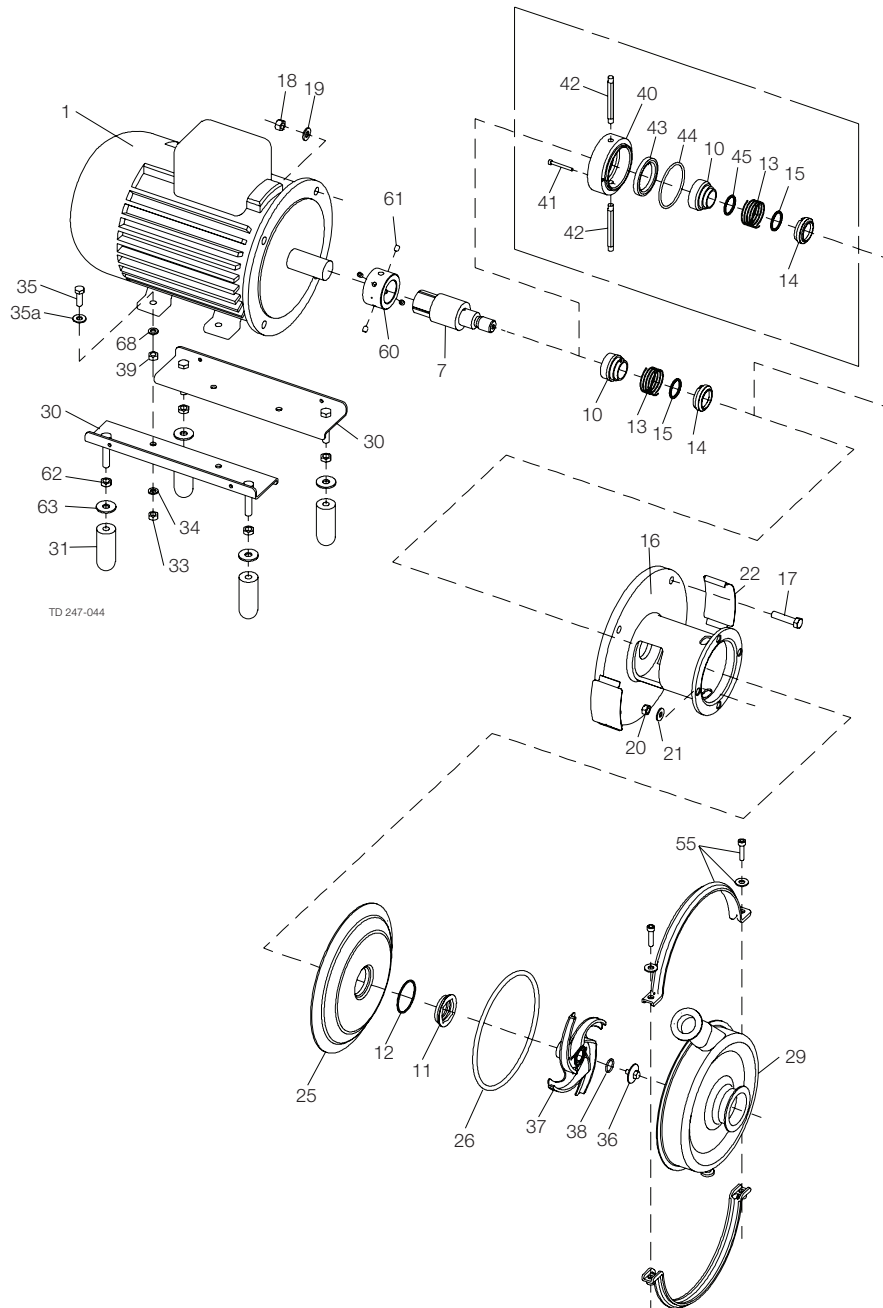

7.2 SolidC UltraPure - Wet end



7 Parts list and service kits

The drawing shows SolidC UltraPure pump, sanitary version. The items refer to the parts lists in the following sections

Parts list

Pos.	Qty	Denomination
20	4	Nut
21	4	Washer
25	1	Backplate compl.
26 	1	O-ring for casing
29	1	Casing
36	1	Impeller screw
37	1	Impeller
38 	1	O-ring for impeller screw
55	1	Clamp set

7 Parts list and service kits

The drawing shows SolidC UltraPure pump, sanitary version. The items refer to the parts lists in the following sections

7.3 SolidC UltraPure - Motor dependent parts

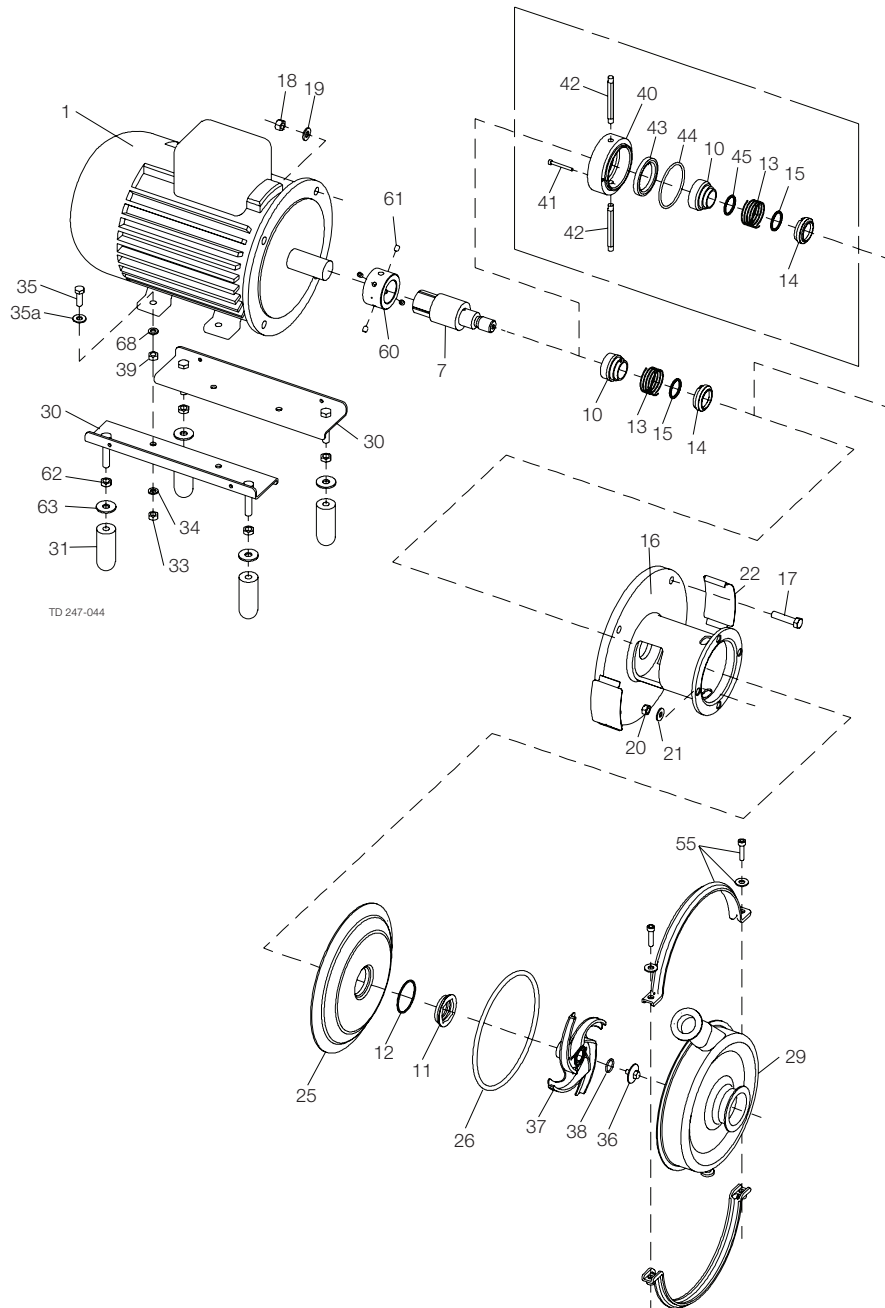

7 Parts list and service kits

The drawing shows SolidC UltraPure pump, sanitary version. The items refer to the parts lists in the following sections

Parts list

Pos.	Qty	Denomination
1	1	Motor WEG
2	1	Shroud
2a	1	Edge list for shroud
3	4	Screw for shroud
7	1	Shaft
16	1	Adaptor
17	4	Screw
18	4	Nut
19	4	Washer
22	2	Safety guard
30	2	Bracket
31	4	Legs
33	4	Nut
34	4	Spring washer
35	4	Screw
35a	4	Washer
39	4	Spacer
60	1	Comp. ring
61	4	Screw
62	4	Nut
63	4	Washer
68	4	Washer

7 Parts list and service kits

The drawing shows SolidC UltraPure pump, sanitary version. The items refer to the parts lists in the following sections

7.4 SolidC UltraPure - Shaft seal

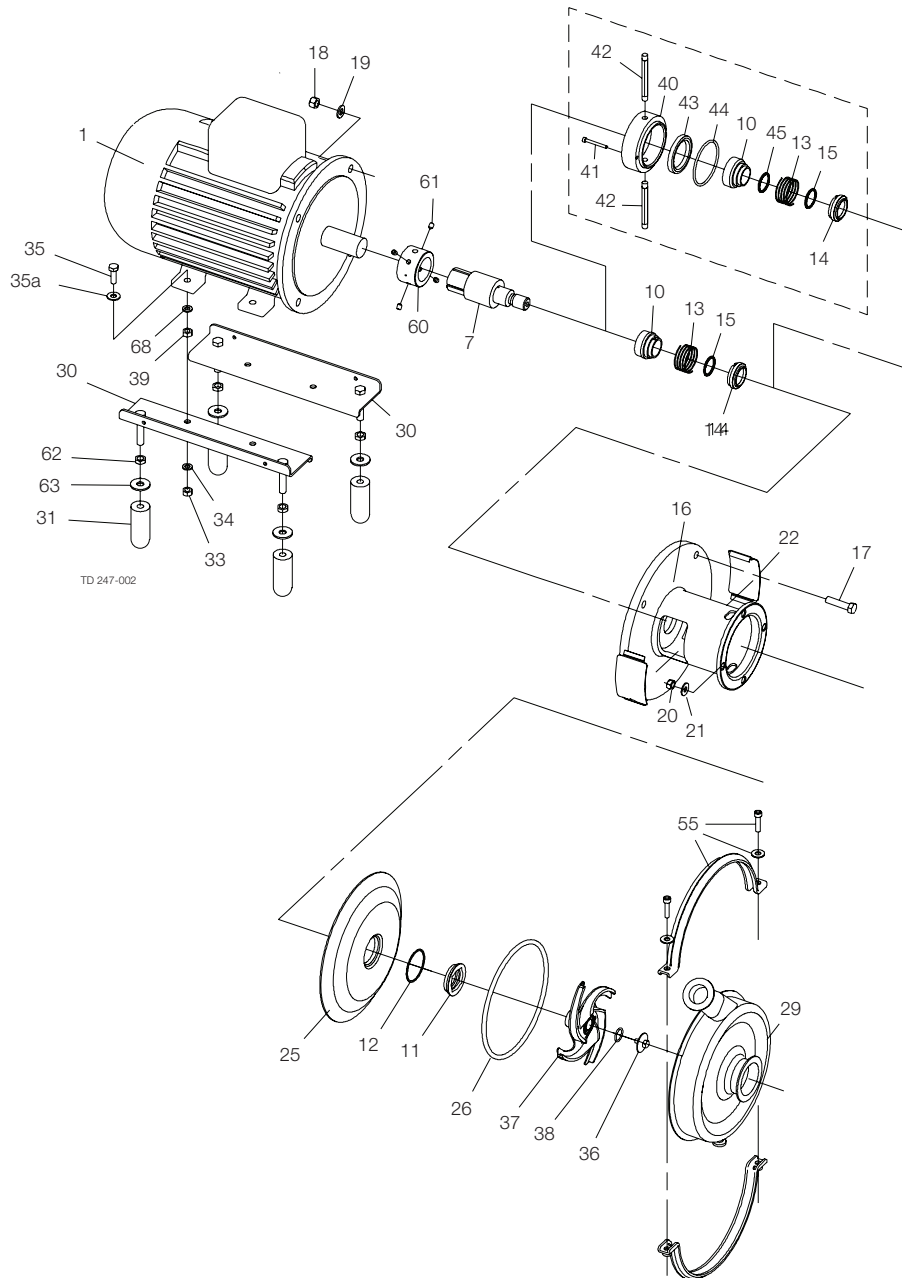

7 Parts list and service kits

The drawing shows SolidC UltraPure pump, sanitary version. The items refer to the parts lists in the following sections

Parts list

Pos.	Qty	Denomination
	1	Impeller gauge
■		Complete shaft seal
◆		Complete shaft seal
1	1	Tool for seal
10	1	Drive ring
11	1	Stationary seal ring
12	1	O-ring
13	1	Spring
14	1	Rotating seal ring
15	1	O-ring
40	1	Seal housing
41	2	Screw for seal housing
42	2	Tube
43	1	Lip seal
44	1	O-ring for seal housing
45	1	O-ring for drive ring

Service kits

Denomination	EPDM	FPM	FEP
Service kit for single shaft seal SiC/SiC			
Service kit, SiC/SiC (Solid C-1 UP)	9611927001	9611927002	9611927003
Service kit, SiC/SiC (Solid C-2 UP)	9611927007	9611927008	9611927009
Service kit, SiC/SiC (Solid C-3 UP)	9611927013	9611927014	9611927015
Service kit, SiC/SiC (Solid C-4 UP)	9611927019	9611927020	9611927021

Service kits

Denomination	EPDM	FPM	FEP
Service kit for flushed shaft seal SiC/SiC			
Service kit, SiC/SiC (Solid C-1 UP)	9611927004	9611927005	9611927006
Service kit, SiC/SiC (Solid C-2 UP)	9611927010	9611927011	9611927012
Service kit, SiC/SiC (Solid C-3 UP)	9611927016	9611927017	9611927018
Service kit, SiC/SiC (Solid C-4 UP)	9611927022	9611927023	9611927024

How to contact Alfa Laval

Contact details for all countries are continually updated on our website.

Please visit www.alfalaval.com to access the information directly.

© Alfa Laval Corporate AB

This document and its contents is owned by Alfa Laval Corporate AB and protected by laws governing intellectual property and thereto related rights. It is the responsibility of the user of this document to comply with all applicable intellectual property laws. Without limiting any rights related to this document, no part of this document may be copied, reproduced or transmitted in any form or by any means (electronic, mechanical, photocopying, recording, or otherwise), or for any purpose, without the expressed permission of Alfa Laval Corporate AB. Alfa Laval Corporate AB will enforce its rights related to this document to the fullest extent of the law, including the seeking of criminal prosecution.